

LC column catalog

L-column series

L-column, High performance column for LC, Since 1990.

L-column2, Super performance column for LC, Since 2007.

L-column

L-column2

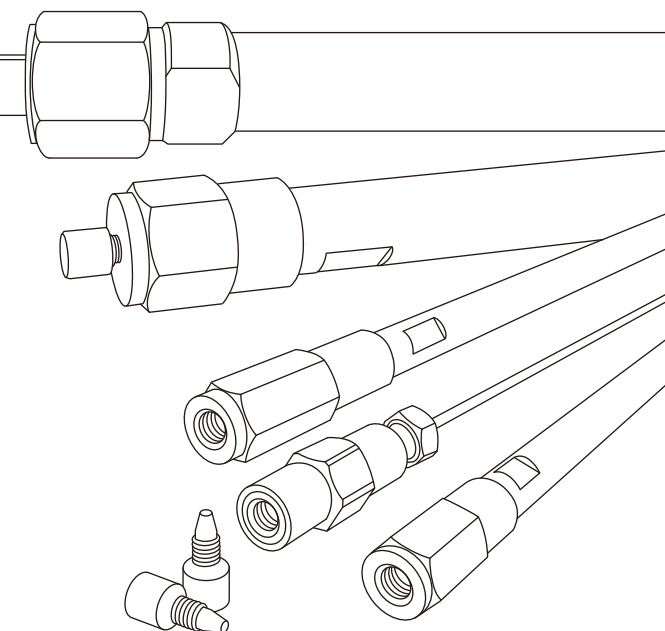

L-column2

- L-column2 ODS

- L-column2 C8

- L-column2 C6-Phenyl

L-column

- L-column ODS

- L-column ODS-P

- L-column C8

Line up

L-column, L-column2

Column developed in pursuit of convenience and high performance.

L-column and L-column2 is the column for reversed-phase high-performance liquid chromatography (RP-HPLC) that enabled separation only by hydrophobic interaction because of inhibition of the secondary interaction with residual silanol groups and metal impurities.

Characteristics of L-column

In 1990, the new end-capping method using high-temperature silylation was invented. The performance of L-column ODS developed using this method was far superior to that of existing C18 columns, and it became a pioneer of the new-generation end-capping method.

Characteristics of L-column2

L-column2, surpassing L-column in performance, was developed by upgrading the end-capping method. There is now a demand for RP-HPLC columns capable of both handling various issues of trace analysis due to the popularization of LC/MS (IMS) and providing advanced analytical precision. L-column2 is an ideal column for meeting this demand.

- Sharper peaks for acidic, basic and coordination compounds due to extremely low silanol adsorption.
- High durability in a wide range of pH and temperature.
- Superior peak shapes in both acetonitrile/water and methanol/water eluents makes L-column2 convenient to use.
- Uniform lot to lot reproducibility of analyses due to extensive quality control measures.

Line up

L-column, L-column2

Packing materials	USP category	Particle Size (μm)	Pore Size (nm)	Micro column	Semi-micro and general-purpose column	Semi preparation column	Metal-free column	
				Inner diameter less than 1 mm	Inner diameter 1 mm or more and less than 10 mm	Inner diameter 10 mm or more		
L-column	L-column ODS	L 1	3, 5	12	○	○	○	-
	L-column ODS-P	L 1	5	30	○	○	-	-
	L-column C8	L 7	5	12	○	○	-	-
L-column2	L-column2 ODS	L 1	2, 3, 5	12	○	○	○	○
	L-column2 C8	L 7	3, 5	12	○	○	-	○
	L-column2 C6-Phenyl	L 11	3, 5	12	○	○	-	○

Classification by inner diameter cited from JIS K 0124:2011

L-column ODS, L-column2 ODS, L-column ODS-P

USP category : L 1

Usable pH range : pH 2 - pH 9

(L-column2 ODS: pH 1 - pH 9)



L-column C8, L-column2 C8

USP category : L 7

Usable pH range : pH 2 - pH 7.5



L-column2 C6-Phenyl

USP category : L 11

Usable pH range : pH 2 - pH 7.5

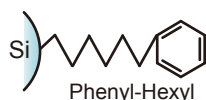

Characteristic test

The characteristic test evaluates the following values:

$\langle \text{Hydrogen bond property} \rangle k(\text{Caffeine}) / k(\text{Phenol})$

This is the value representing the influence of the hydrogen bond of the silanol group of packing materials and the samples as represented by the ratio of the retention factors of caffeine with high hydrogen bond property and phenol with low hydrogen bond property. The larger the value of "hydrogen bond property", the hydrogen bonds are easy to occur between analyte and packing materials.

$\langle \text{Hydrophobicity} \rangle k(\text{Amylbenzene}) / k(\text{Butylbenzene})$

This is the value representing the magnitude of the retention force of packing materials as represented by the ratio of the retention factors of amyl benzene and butyl benzene. The larger the value of hydrophobicity, the higher the hydrophobicity of the packing materials and the longer the retention time.

$\langle \text{Stereoselectivity} \rangle k(\text{Triphenylene}) / k(\text{o-Terphenyl})$

This is the value representing the plane recognition ability as represented by the ratio of the retention factors of triphenylene with a plane structure and o-terphenyl with a three-dimensional structure. The larger the value of stereoselectivity, the stronger the retention of a compound with a plane structure.

L-column2 ODS

Cat.No.721070

Hydrogen bond property : 0.46
Hydrophobicity : 1.46
Stereoselectivity : 1.61

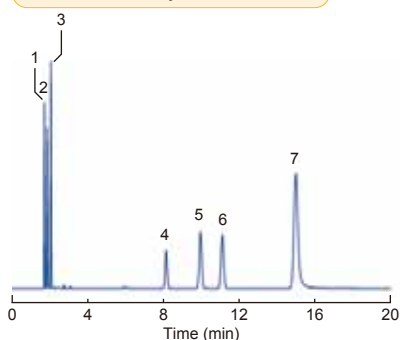

L-column2 C8

Cat.No.721071

Hydrogen bond property : 0.40
Hydrophobicity : 1.35
Stereoselectivity : 1.38

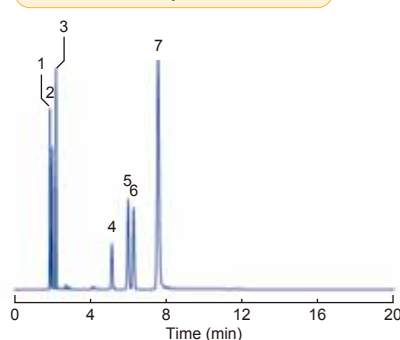

L-column2 C6-Phenyl

Cat.No.721076

Hydrogen bond property : 1.37
Hydrophobicity : 1.32
Stereoselectivity : 1.52

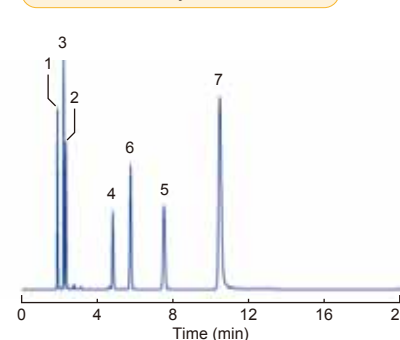

[Analytical conditions]

Column: 3 μm ; Size: 4.6 mm I.D., 150 mm L.; Eluent: $\text{CH}_3\text{OH}/\text{H}_2\text{O}$ (80/20); Flow rate: 1 mL/min; Temp.: 42 °C; Detection: UV 254 nm; Inj. vol.: 1 μL

Sample: 1. Uracil (t_0 marker)

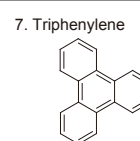
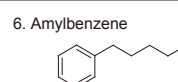
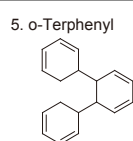
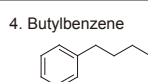
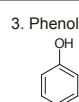
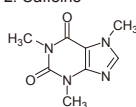

The retention time of the analytes changes greatly due to each column (C18, C8 and phenyl columns) characteristics. It is possible to improve the separation of analytes and shorten the analytical time by using each column properly.

L-column2 ODS

Cat.No.711020

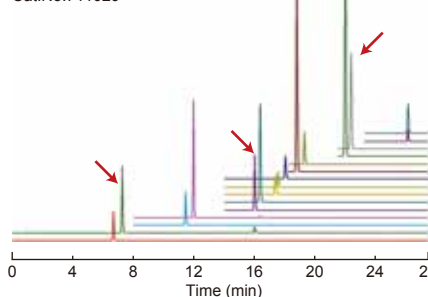

L-column2 C8

Cat.No.712021

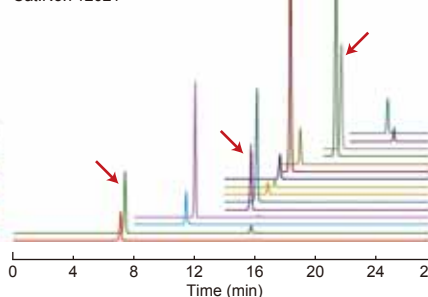

L-column2 C6-Phenyl

Cat.No.712026

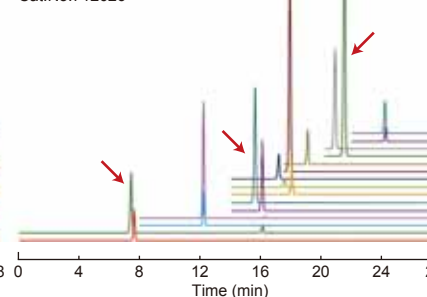

■ Agricultural chemicals (1 mg/L each)

[Analytical conditions]

Column: 3 μm or 5 μm ; Size: 2.1 mm I.D. \times 150 mm L.

Eluent: A: CH_3CN , B: 0.1% HCOOH in H_2O ; A/B, 5/95-100/0(0-40 min); Flow rate: 0.2 mL/min; Temp.: 40 °C; Detection: ESI-MS(+); Inj. Vol.: 10 μL

Base silica

High purity silica, in which metal impurities are reduced to the absolute limit, is used as the starting material, facilitating analysis of coordination compounds.

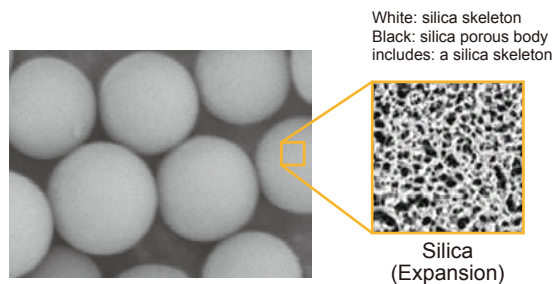

Silica test specifications (extract)

Analytical results for packing materials	Specification
Surface area (ave.)	340 m ² /g
Median pore diameter (ave.)	12 nm
Metal contents:	
Al	< 5.0 ppm
Fe	< 10.0 ppm
Na	< 10.0 ppm
Ti	< 0.5 ppm

End-capping

Various end-capping methods are used by column manufacturers, but the residual silanol groups cannot thoroughly be eliminated by the usual end-capping methods. The residual silanol groups of *L-column* and *L-column2* are almost entirely eliminated. Therefore, peak tailing derived from the residual silanol groups does not occur using *L-column* ODS and its high durability, even in acidic or basic eluent, minimizes deterioration.

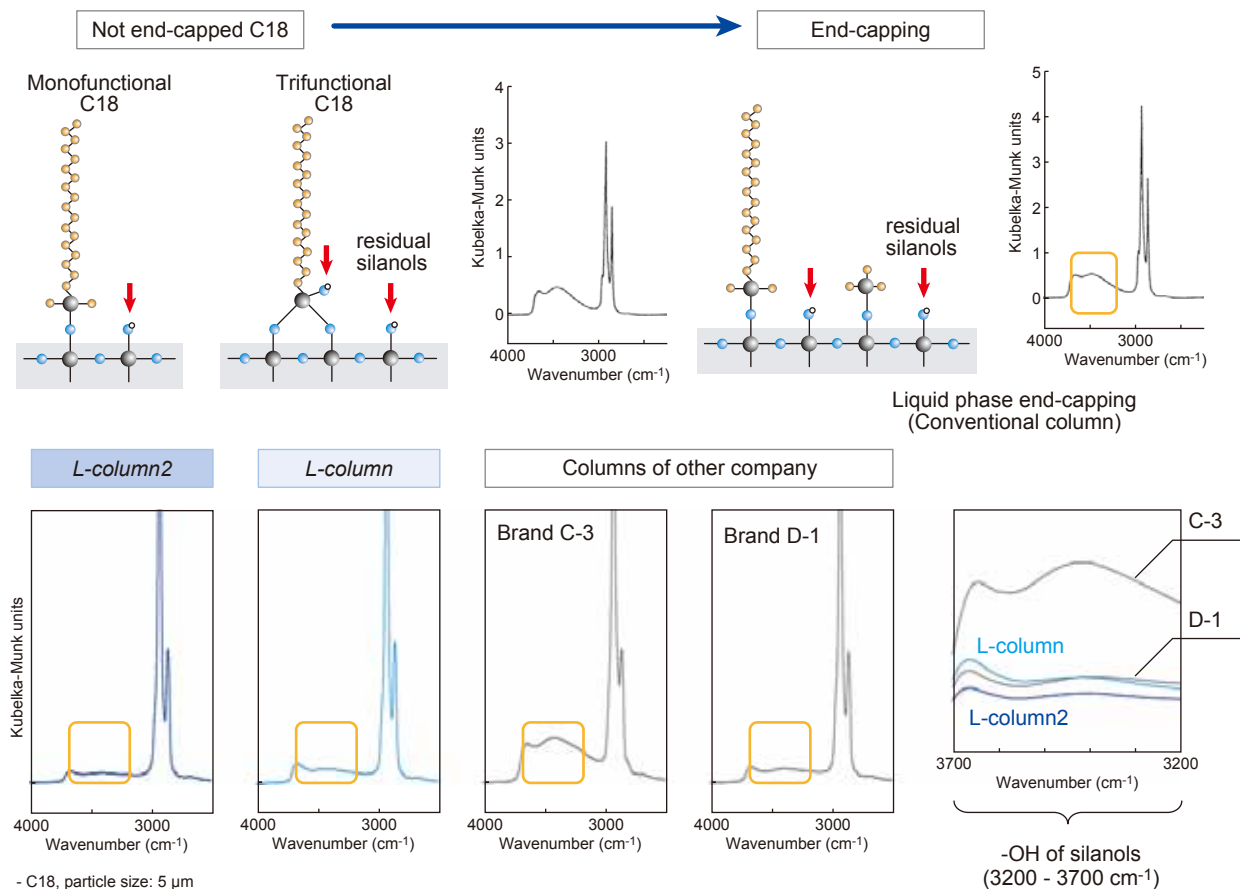

The level of residual silanol groups is measured by FT-IR spectrum. The spectra of C18 without end-capping and the fully end-capped *L-column2* are shown. The spectrum region for C-H and O-H provides quantitative information as well as qualitative identification. FT-IR spectra show virtually no presence of silanol groups on *L-column2*. In addition, the spectrum region for O-H (the right spectra) shows that *L-column2* has the least residual silanol groups of any column tested.

Comparison between L-column2 and other columns

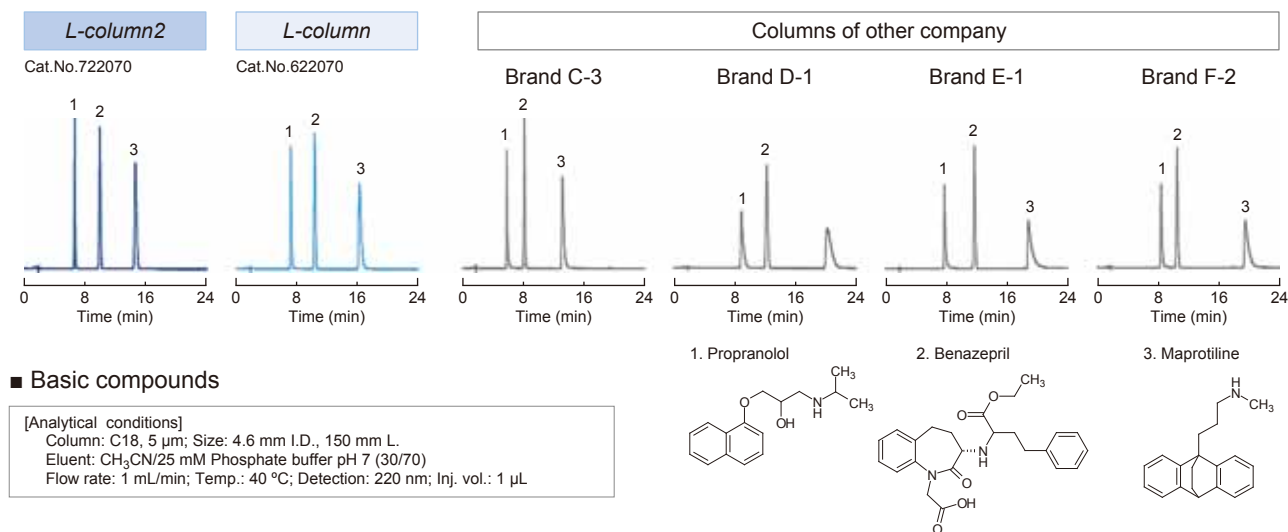

Basic compounds

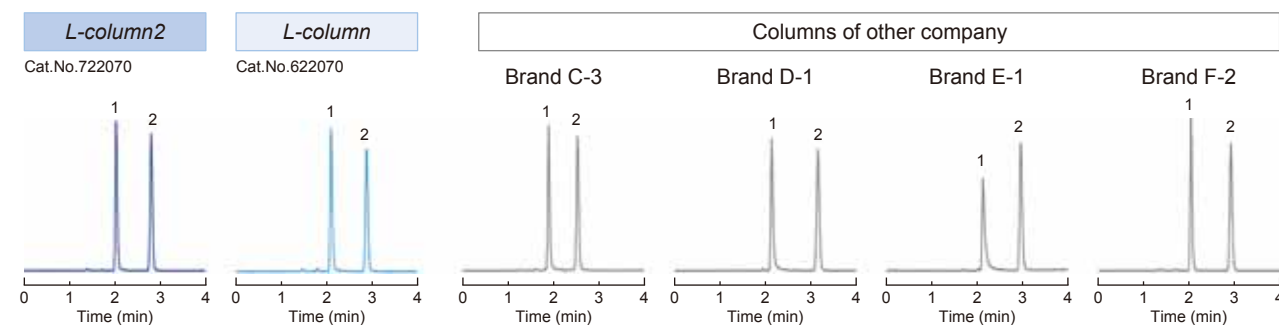

Acidic compounds

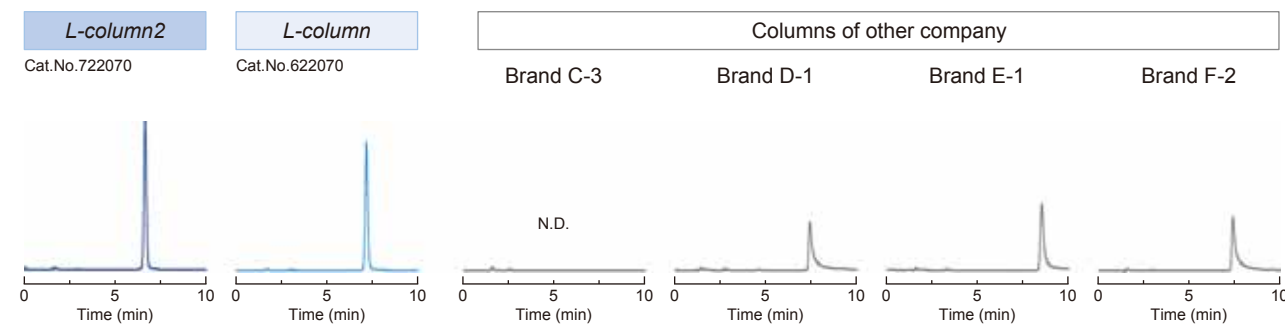

Coordination compound

[Analytical conditions]
Column: C18, 5 μ m; Size: 4.6 mm I.D., 150 mm L.
Eluent: CH₃CN/20 mM H₃PO₄ in H₂O (40/60)
Flow rate: 1 mL/min; Temp.: 40 °C; Detection: 240 nm; Inj. vol.: 10 μ L

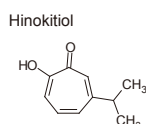

Improved durability

A durability test was carried out under high temperature conditions which accelerate deterioration of columns. *L-column2* ODS was stable for the longest time. Although it is silica-based, it shows superior durability even under alkaline conditions due to the extremely dense end-capping.

[Accelerated acidic eluent lifetime test]

Under acidic conditions, below pH 1, both the end-capping group and the ODS group are hydrolyzed. Retention time decreases with the decrease of ODS groups. Resolution decreases with the progression of the hydrolysis. *L-column2* ODS resists hydrolysis even under these harsh conditions to maintain retention and resolution for an extended lifetime.

■ Durability test (under pH 1, 90 °C)

[Durability test conditions]
 Column: C18, 5 μ m
 Size: 4.6 mm I.D., 150 mm L.
 Eluent: CH₃OH/2% TFA in H₂O (10/90)
 Flow rate: 1 mL/min; Temp.: 90 °C

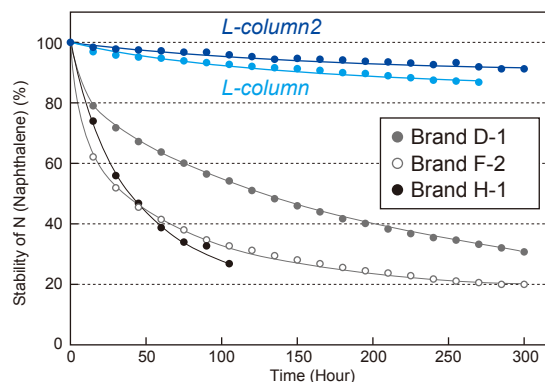

L-column2 ODS

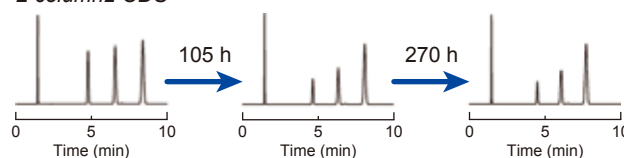

Brand H-1

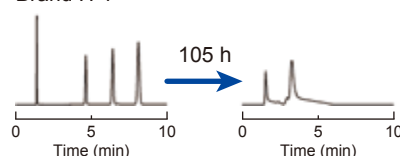

[Accelerated alkaline eluent lifetime test]

Dissolution of the base silica is accelerated in alkaline eluent. Efficiency (theoretical plate number) drops suddenly in these conditions. *L-column2* ODS has superior durability under high pH conditions due to the protection of the silica surface afforded by the advanced end-capping process.

■ Durability test (pH 10, 50 °C)

[Durability test conditions]
 Column: C18, 5 μ m
 Size: 4.6 mm I.D. × 150 mm L.
 Eluent: CH₃OH/50 mM TEA in H₂O (10/90)
 Flow rate: 1 mL/min; Temp.: 50 °C

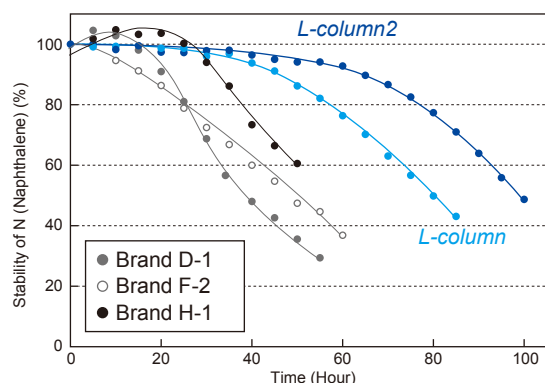

L-column2 ODS

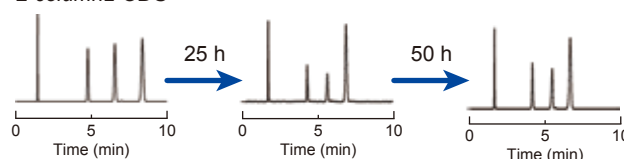

Brand H-1

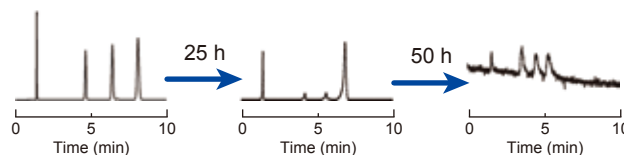

Superior reproducibility

Variation between product lots due to residual silanol groups is prevented by superior end-capping. Although reproducibility of retention times of basic compounds is poor between product lots, the coefficient of variation of the retention times between the product lots is under 1% for *L-column2 ODS*. Regardless of the product lot, *L-column2 ODS* provides the same results in HPLC analysis because of thorough quality control.

Antidepressants

[Analytical conditions]
 Column: *L-column2 ODS*, 5 μm
 Size: 4.6 mm I.D., 150 mm L. (Cat.No.722070)
 Eluent: $\text{CH}_3\text{CN}/25$ mM Phosphate buffer pH 7 (60/40)
 Flow rate: 1 mL/min
 Temp.: 40 $^\circ\text{C}$; Detection: 220 nm; Inj. vol.: 1 μL

1. Doxepin

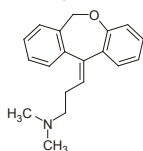

2. Imipramine

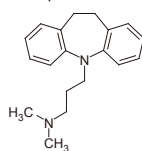

3. Amitriptyline

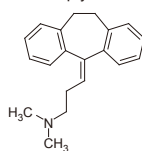

4. Mianserin

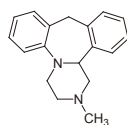

5. Clomipramine

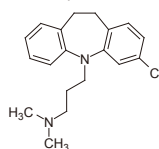

6. Trimipramine

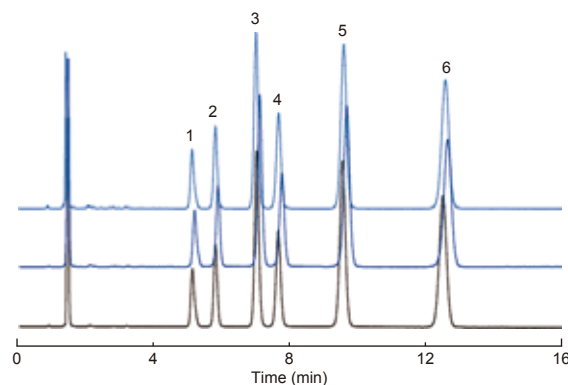
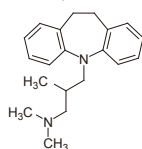

Lot.No.	$t_{R(1)}$	$t_{R(2)}$	$t_{R(3)}$	$t_{R(4)}$	$t_{R(5)}$	$t_{R(6)}$
A	5.115	5.796	7.008	7.647	9.546	12.508
B	5.180	5.868	7.103	7.755	9.669	12.648
C	5.184	5.823	7.022	7.687	9.609	12.608
CV(%)	0.647	0.626	0.725	0.707	0.640	0.575

Hinokitiol

[Analytical conditions]
 Column: *L-column2 ODS*, 5 μm
 Size: 4.6 mm I.D., 150 mm L. (Cat.No.722070)
 Eluent: $\text{CH}_3\text{CN}/20$ mM H_3PO_4 in H_2O (40/60)
 Flow rate: 1 mL/min
 Temp.: 40 $^\circ\text{C}$; Detection: 240 nm; Inj. vol.: 1 μL

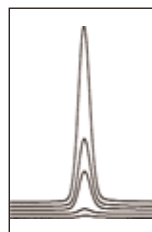

[Calibration curve]

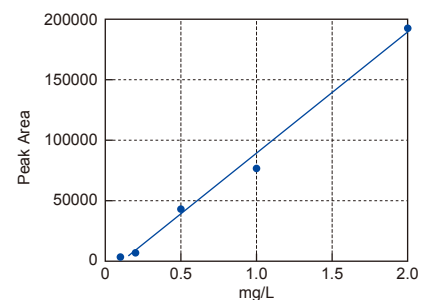

Cartification (Certificate of analysis)

Specifications and test results of each product lot as well as test results for each column are supplied with the column.

L-column2 Certificate of analysis			
L-column2 ODS Lot No. E0000			
Analytical Results for Packing	Materials	Specification	Result
Analysis of unbound Silica gel			
Median Particle Size(d50)	[μm]	0.0-0.0	
Surface Area*	[m^2/g]	000-000	
Median Pore Diameter*	[nm]	00.0-00.0	
Pore Volume*	[mL/g]	0.00-0.00	
Metal contents**			
Al	[ppm]	< 0.0	
Fe	[ppm]	< 0.0	
Na	[ppm]	< 0.0	
Ti	[ppm]	< 0.0	
* Coulter counter method, ** BET method, *** CP-ACS			
Analytical Results for: L-column2			
Carbon content	[%]	0.0-0.0	
Chromatographic Results			
Test A: N(Naphthalene)		0.000-0.000	
Test B: N(Propylene)(Phenol)		0.000-0.000	
Test C: N(Caffeine)(Phenol)		0.000-0.000	
Test D: N(Armylbenzene)(Benzene)		0.000-0.000	
Test E: N(Triphenylacetic)(Triphenyl)		0.000-0.000	
Test F: N(Acetylphenone)(Amphetamine)		0.000-0.000	
Test G: N(Caffeine)(Caffeine)		0.000-0.000	
Test H: N(Ferrocene)		>0.000	
Approved: _____ Date: _____			

L-column2 ODS Next generation high performance silica-based ODS column.

L-column2 ODS exceeds even the high performance of L-column ODS by virtue of its advanced new end-capping method. It can be used for the analysis of acidic, basic and coordination compounds.

Properties

Particle size	2 μm , 3 μm , 5 μm
Pore size	12 nm
Surface area	340 m ² /g
Carbon contents	17%
Bonded phase	Octadecyl silyl (C18, ODS)
End-capping	Advanced end-capping
USP category	L 1
Usable pH range	pH 1 - pH 9



Comparison between L-column2 ODS and other columns

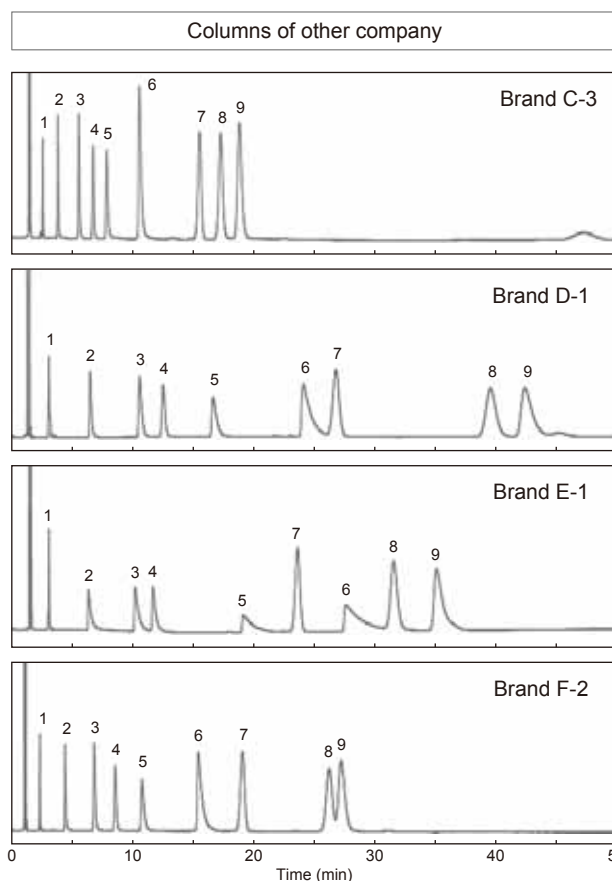
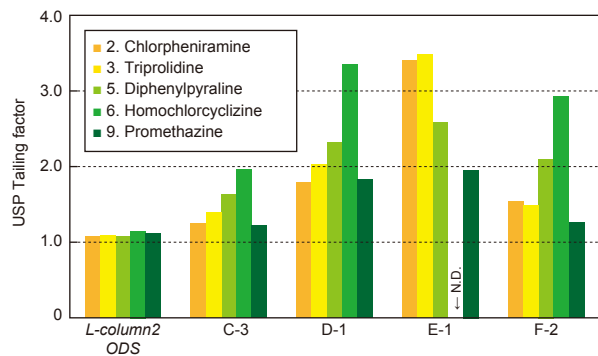
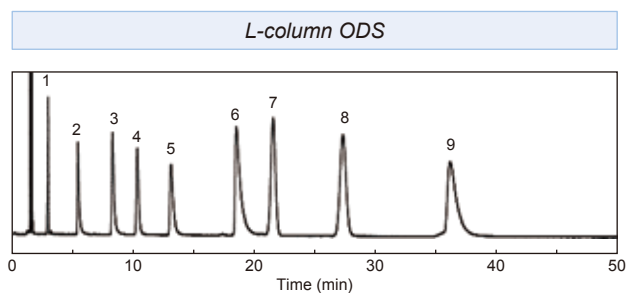
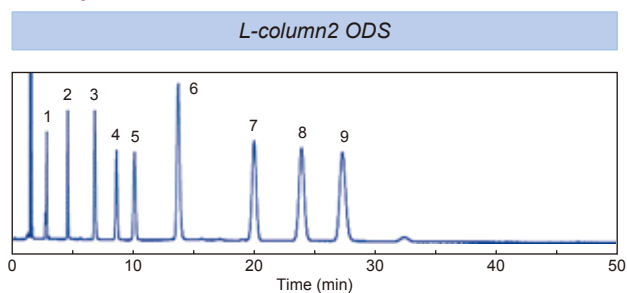

■ Antihistamines

[Analytical conditions]
 Column: C18, 5 μm
 Size: 4.6 mm I.D., 150 mm L.
 Eluent: CH₃CN/25 mM Phosphate buffer pH 7 (40/60)
 Flow rate: 1 mL/min
 Temp.: 40 °C; Detection: 220 nm; Inj. vol.: 1 μL
 Sample: 1. Fexofenadine; 2. Chlorpheniramine; 3. Triprolidine;
 4. Diphenhydramine; 5. Diphenylpyraline; 6. Homochlorcyclizine;
 7. Hydroxyzine; 8. Astemizole; 9. Promethazine

L-column2 ODS is perfectly end-capped, so it does not adsorb analytes using any composition of eluents and provides a superior peak shape. In almost all C18 columns, peak tailing of basic compounds using these eluents occurs, but in L-column2 ODS does not occur.

Therefore, it can be used in a wide range of compositions of eluents. This is an important point when selecting a column.

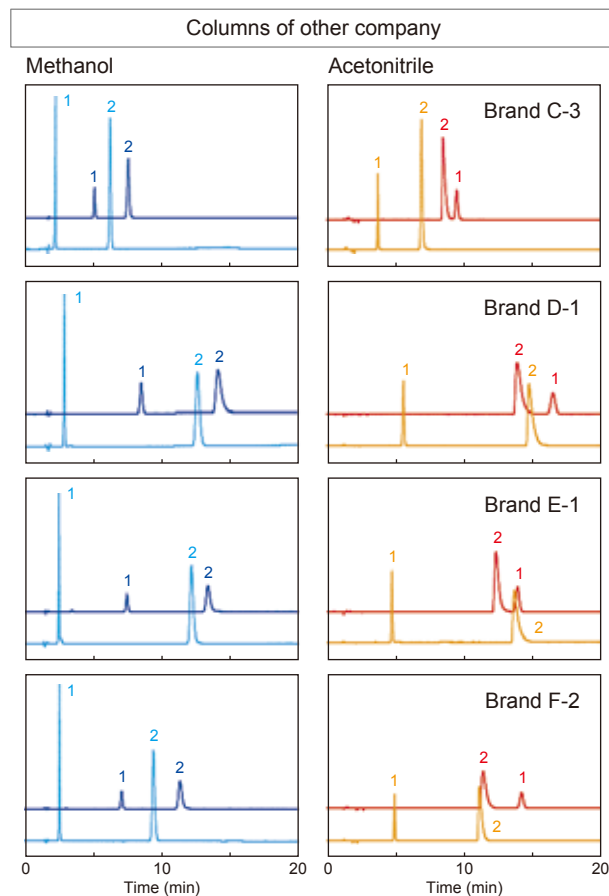
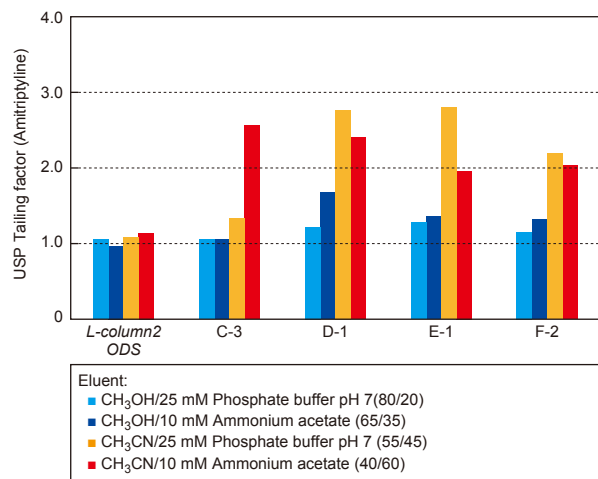
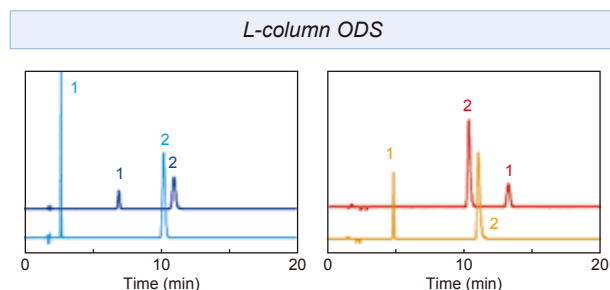
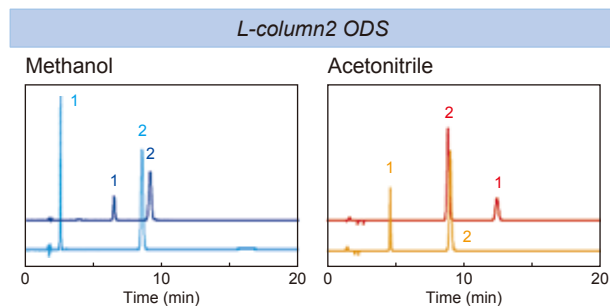

■ Antidepressant

[Analytical conditions]
 Column: C18, 5 μm
 Size: 4.6 mm I.D., 150 mm L.
 Flow rate: 1 mL/min
 Temp.: 40 °C; Detection: 220 nm; Inj. vol.: 5 μL

1. n-Butyl p-hydroxybenzoate(I.S.)

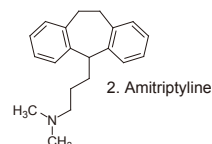
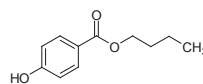

Basic compounds show peak tailing due to their adsorption by residual silanol groups. Therefore, adsorption is inhibited using an acidic eluent or a eluent including methanol to control peak tailing. Because the residual silanol groups show intrinsic activity using a neutral eluent or a eluent including acetonitrile as an organic solvent, peak tailing of basic compounds due to adsorption occurs when using poorly end-capped columns.

L-column2 C8

Next generation high performance silica-based octyl column.

L-column2 C8 is end-capped using the same advanced method used for L-column2 ODS. This column is easy to use because it provides sharp peaks in addition to it having high durability. L-column2 C8 is most suitable for reducing the analysis time of hydrophobic compounds and conserving solvent.

Properties

Particle size	3 μm, 5 μm
Pore size	12 nm
Surface area	340 m ² /g
Carbon contents	10%
Bonded phase	Octyl silyl (C8)
End-capping	Advanced end-capping
USP category	L 7
Usable pH range	pH 2 - pH 7.5



Comparison between C8 column and C18 column

■ Reduction of analysis time

In general, the retention time for C8 columns is short because they have lower retention ability than C18 columns. The analysis time of hydrophobic analytes can be shortened, thus reducing the amount of solvent used.

Chromatogram of fat-soluble vitamins shows results from analysis of Fat-soluble vitamins using L-column2 ODS and L-column2 C8 under the same HPLC conditions. Although the analysis of vitamin K using L-column2 ODS columns takes longer because the lipophilicity of vitamin K is high, the analysis time using L-column2 C8 is one quarter of that using L-column2 ODS.

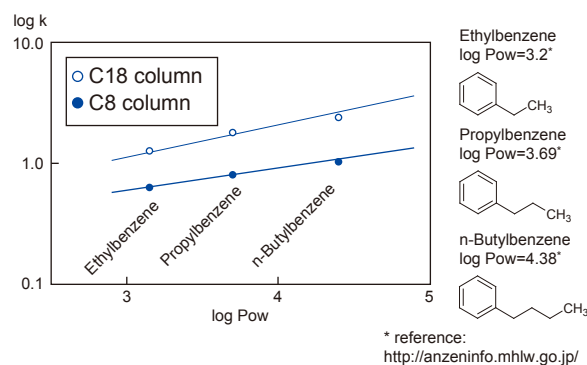

■ Alkylbenzenes

[Analytical conditions]
Column: 5 μm
Size: 4.6 mm I.D., 150 mm L.
Eluent: CH₃OH/H₂O (85/15)
Flow rate: 1 mL/min
Temp.: 40 °C; Detection: 254 nm; Inj. vol.: 1 μL

■ Fat-soluble vitamins

[Analytical conditions]
Column: 5 μm
Size: 4.6 mm I.D., 150 mm L.
Eluent: CH₃CN/CH₃OH/H₂O (76/19/5)
Flow rate: 1 mL/min
Temp.: 40 °C; Detection: 285 nm; Inj. vol.: 2 μL

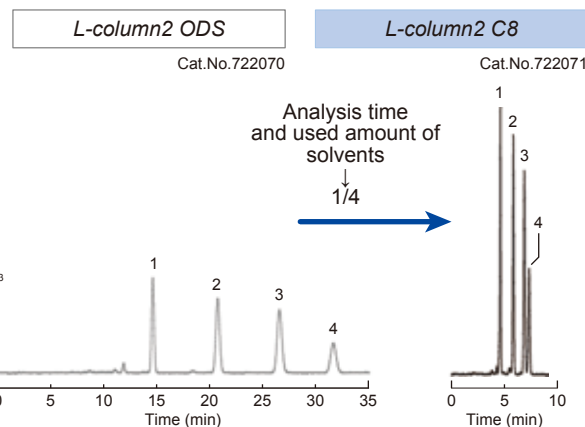
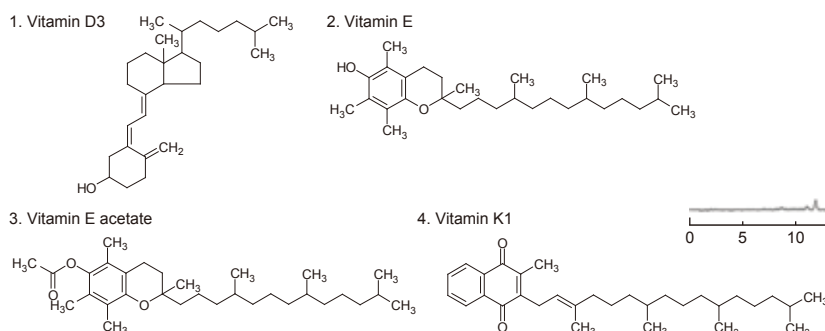

■ Difference of separation behavior with C18 column
Compared to C18 columns, almost all analytes are eluted faster on C8 columns, but the difference between the retention time for C8 columns and that for C18 columns depends on the analytes. Because the elution behavior of C8 columns is sometimes different from that of C18 columns, C8 columns can sometimes improve separation even if separation using C18 columns is not possible.

■ Antidepressants

[Analytical conditions]
Column: 5 μ m
Size: 4.6 mm I.D., 150 mm L.
Eluent: CH₃CN/25 mM Phosphate buffer pH 7 (30/70)
Flow rate: 1 mL/min
Temp.: 40 °C; Detection: 220 nm; Inj. vol.: 1 μ L
Sample: 1. Sulpiride; 2. Desipramine; 3. Paroxetine; 4. Maprotiline;
5. Amoxapine; 6. Trazodone

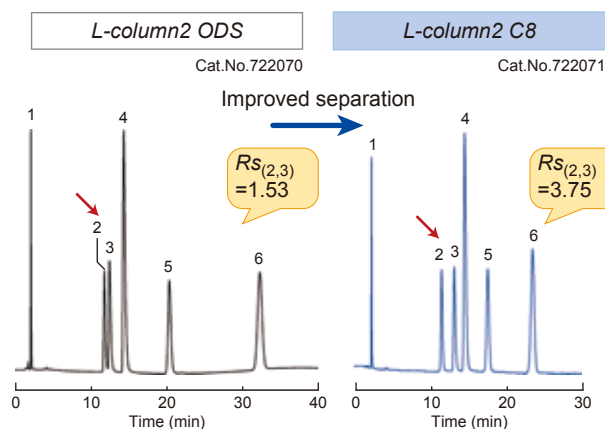

Comparison between L-column2 C8 and other columns

L-column2 C8

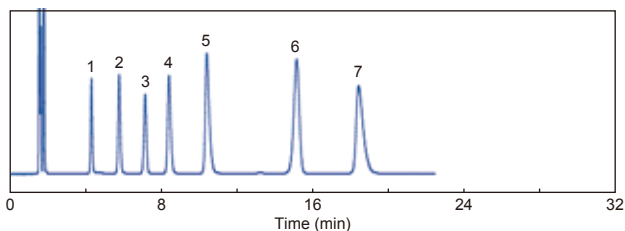

Columns of other company

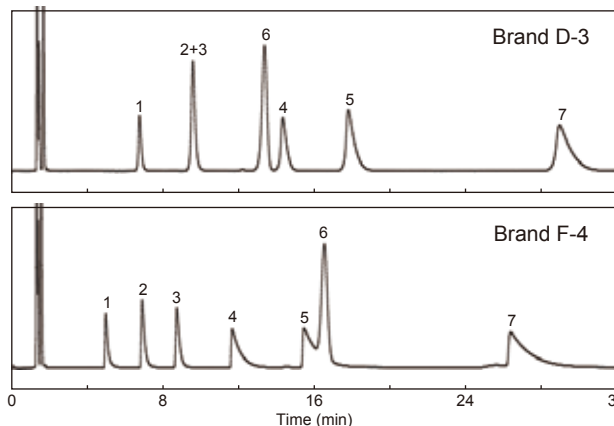

■ Antihistamines

[Analytical conditions]
Column: C8, 5 μ m
Size: 4.6 mm I.D. x 150 mm L.
Eluent: CH₃CN/25 mM Phosphate buffer pH 7.0 (40/60)
Flow rate: 1 mL/min
Temp.: 40 °C; Detection: 220 nm; Inj. vol.: 1 μ L
Sample: 1. Chlorpheniramine; 2. Triprolidine; 3. Diphenhydramine;
4. Diphenylpyraline; 5. Homochlorcyclizine; 6. Hydroxyzine;
7. Clemastine

■ Durability test (under pH 1)

[Durability test conditions]
Column: C8, 5 μ m
Size: 2.1 mm I.D. x 150 mm L.
Eluent: CH₃OH/H₂O/TFA (10/90/1)
Flow rate: 0.2 mL/min; Temp.: 40 °C

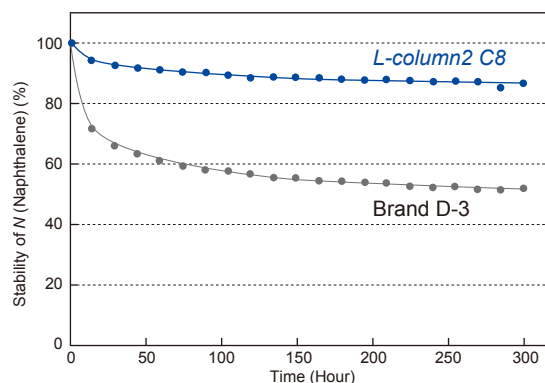

L-column2 C6-Phenyl

Next generation high performance silica-based phenyl column.

The main retention mechanisms of *L-column2 C6-Phenyl* are π - π interaction and hydrophobicity.

L-column2 C6-Phenyl can use the same eluent as an C18, and can obtain some different separation patterns.

Properties

Particle size	3 μ m, 5 μ m
Pore size	12 nm
Surface area	340 m ² /g
Carbon contents	13%
Bonded phase	Phenyl-hexyl silyl (C6-Phenyl)
End-capping	Advanced end-capping
USP category	L 11
Usable pH range	pH 2 - pH 7.5

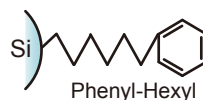

Comparison between phenyl column and C18 column

■ π - π interaction

The separation behaviors of nitrobenzenes in different stationary phases were compared.

The retention of C18 column and Phenyl column without alkyl spacer becomes stronger in order of strong hydrophobicity of nitrobenzenes.

The retention of phenyl column with spacer becomes stronger as the number of nitro groups increases, and the retention mechanism by π - π interaction appears strongly.

■ Nitrobenzenes

[Analytical conditions]
 Column: 5 μ m
 Size: 4.6 mm I.D. \times 150 mm L.
 Eluent: CH₃OH/H₂O (50/50)
 Flow rate: 1 mL/min
 Temp.: 40 °C; Detection: 210 nm; Inj. vol.: 1 μ L

1. Nitrobenzene log Pow=1.86^{*} 2. 1,3-Dinitrobenzene log Pow=1.49^{*} 3. 1,3,5-Trinitrobenzene log Pow=1.18^{*}

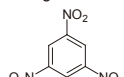

* References:
<http://anzeninfo.mhlw.go.jp/>

■ Basic drugs

[Analytical conditions]
 Column: 5 μ m
 Size: 2.1 mm I.D., 150 mm L.
 Eluent: A: 0.1% HCOOH in CH₃CN; B: 0.1% HCOOH in H₂O
 A/B, 5/95-70/30 (0-45 min)
 Flow rate: 0.3 mL/min
 Temp.: 40 °C; Detection: ESI-MS(+); Inj. vol.: 1 μ L
 Sample: 1. Yohimbine; 2. Prazosin; 3. Trazodone; 4. L-Alprenolol;
 5. Isopropylantipyrine; 6. Clemastine; 7. Ibudilast

L-column2 C6-Phenyl with hexyl spacer is designed to take full advantage of the π - π interaction.

The unique structure is the feature of *L-column2 C6-Phenyl* and allows column selection for improved separation.

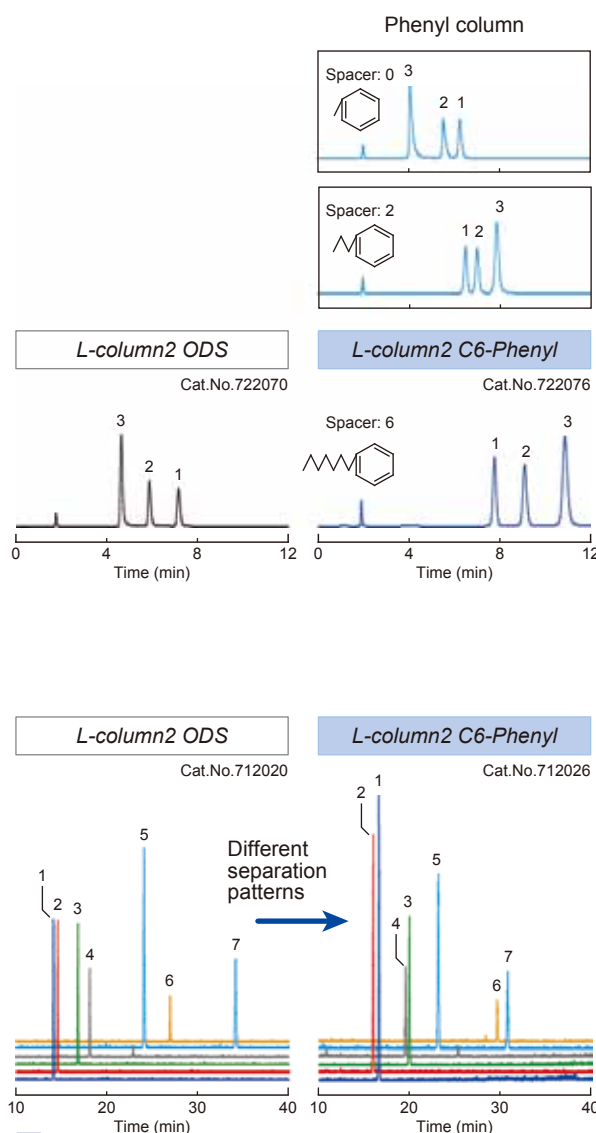

■ Coordination compound

[Analytical conditions]
 Column: 5 μ m
 Size: 4.6 mm I.D., 150 mm L.
 Eluent: CH₃CN/20 mM H₃PO₄ (10/90)
 Flow rate: 1 mL/min
 Temp.: 40 °C; Detection: 294 nm; Inj. vol.: 2 μ L(2 g/L)

3. Levofloxacin

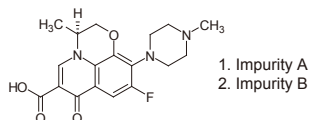

Chromatogram is comparing impurities in levofloxacin under the same analytical conditions. Levofloxacin is a new quinolone synthetic antibacterial agent that is easy to coordinate with metals.

L-column2 C6-Phenyl shows some good peak shapes, and more impurities than C18 have been separated.

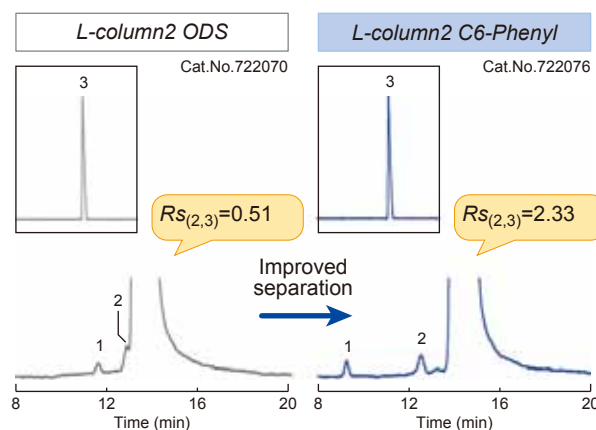

■ Calcium antagonists

[Analytical conditions]
 Column: 5 μ m
 Size: 4.6 mm I.D., 150 mm L.
 Eluent: CH₃CN/25 mM Phosphate buffer pH 7 (50/50)
 CH₃OH/25 mM Phosphate buffer pH 7 (70/30)
 Flow rate: 1 mL/min
 Temp.: 40 °C; Detection: 235 nm; Inj. vol.: 1 μ L
 Sample: 1. Nifedipine; 2. Nitrendipine; 3. Diltiazem; 4. Verapamil;
 5. Nicardipine

L-column2 C6-Phenyl has greater retention time than ODS column, when methanol is used as the eluent. It is considered that methanol does not interfere with the π - π interaction between the phenyl group and the analytes because methanol does not have π electrons in its structure.

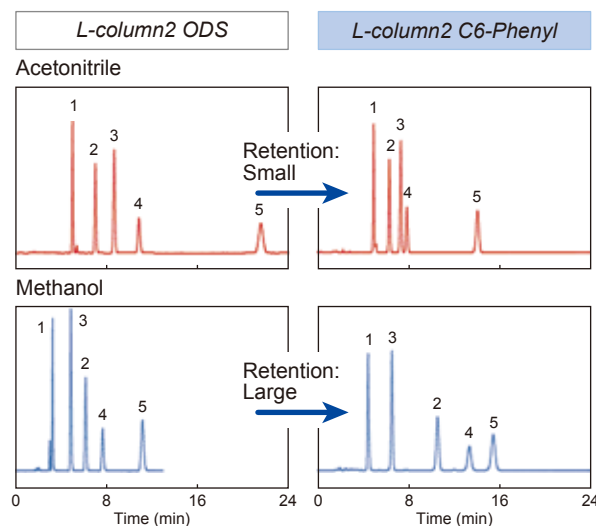

Comparison between *L-column2 C6-Phenyl* and other columns

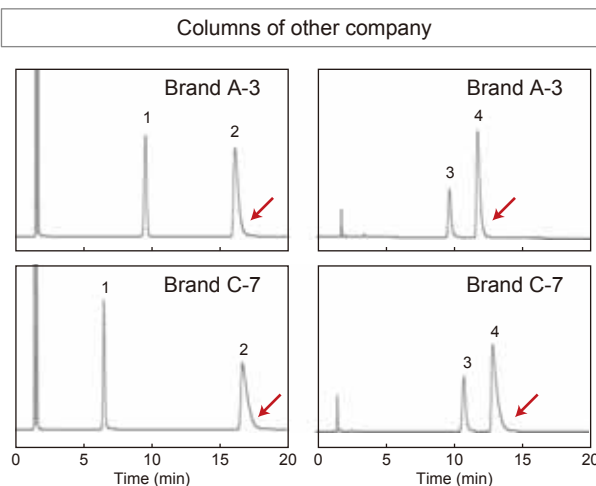
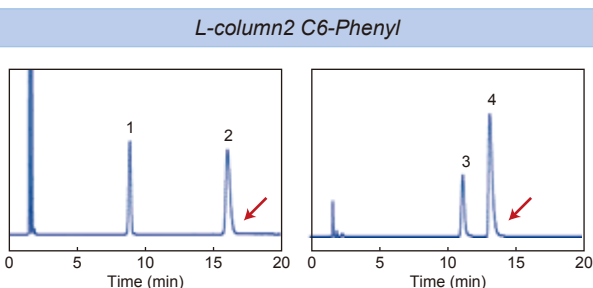

■ Basic drugs

[Analytical conditions]
 Column: Phenyl-Hexyl, 5 μ m
 Size: 4.6 mm I.D., 150 mm L.
 Eluent: CH₃CN/25 mM Phosphate buffer pH 7
 Flow rate: 1 mL/min
 Temp.: 40 °C; Detection: 220 nm; Inj. vol.: 1 μ L
 Sample: 1. Butyl p-Hydroxybenzoate; 2. Clemastine;
 3. Propranolol; 4. Dextromethorphan

L-column Micro High-performance column for nano and micro HPLC.

L-column Micro is a nano/micro column with 0.075–0.3 mm I.D. It is a high-performance column that was manufactured by combining low-adsorption packing materials, including *L-column2 ODS*, an originally developed packing technique and a column structure with a small dead volume.

Column Structure

[PEEK-sleeved type]

This column is easy to handle because it is a fused silica capillary with an outer sleeve of PEEK resin. Connection to MS is easy because connectors are attached to the column.

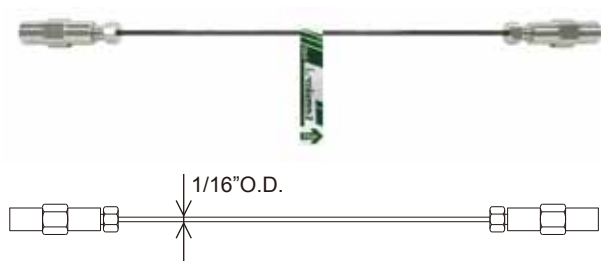

Fused silica capillary, PEEK
Connection: 1/16 inch stainless-steel connector

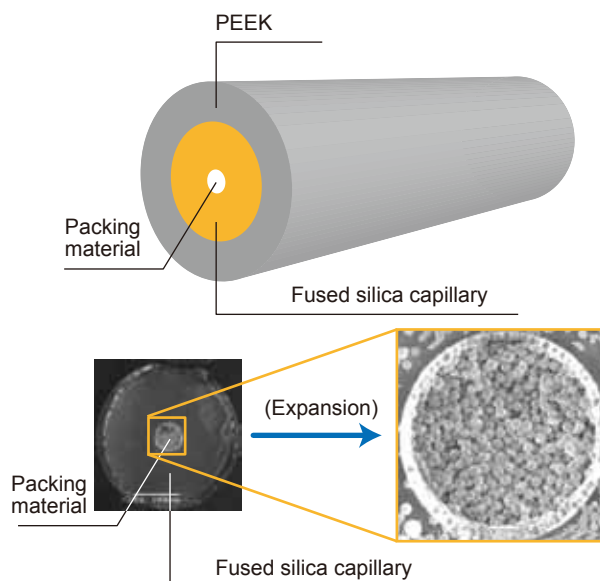

Electron microgram (0.075 mm I.D.).

Cover ratio

BSA tryptic digest was analyzed using LC/MS/MS and the sample concentration and cover ratio was determined using *L-column Micro* and another brand. A higher cover ratio means that more amino acid sequences are read.

■ Tryptic digest of BSA

[Analytical conditions]
Column: C18, 3 μ m
Size: 0.075 mm I.D., 150 mm L.
Eluent: CH₃CN/0.1% HCOOH in H₂O
Flow rate: 0.25 μ L/min
Temp.: Ambient

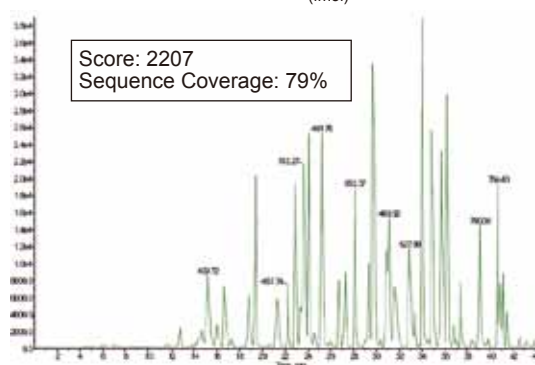
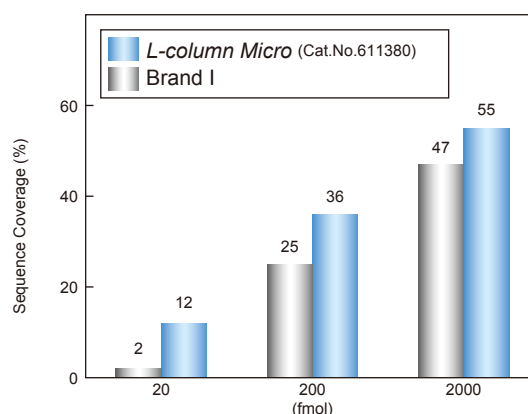

L-column Micro shows advantage at all concentration levels, but excels at the lower levels. With superior end-capping and very high theoretical plate numbers per column, *L-column Micro* permits identification of many proteins and is the optimum choice for proteome analysis.

■ Tryptic digest of BSA (50 fmol)

[Analytical conditions]
Column: L-column2 ODS, 3 μ m
Size: 0.075 mm I.D., 150 mm L.; PEEK-sleeved type (Cat.No.711400)
Eluent: CH₃CN/0.1% HCOOH in H₂O, gradient elution
Flow rate: 0.2 μ L/min
Temp.: Ambient

- Courtesy of Dr. Ueda, RIKEN center for Genomic Medicine

Low adsorption and high efficiency

L-column Micro can separate many peptides because of the low-adsorption packing materials. This is effective for the identification of proteins. The column has a high theoretical plate number and high durability because it is packed homogeneously by a patented technique.

■ Tryptic digest of Enolase 1 (100 fmol)

[Analytical conditions]
 Column: C18, 3 μm
 Size: 0.075 mm I.D., 150 mm L.
 Eluent: A: 0.1% HCOOH in CH_3CN ; B: 0.1% HCOOH in H_2O
 A/B, 5/95-40/60 (0-30 min)
 Flow rate: 0.25 - 0.3 $\mu\text{L}/\text{min}$
 Temp.: Ambient; Inj.vol.: 1 μL

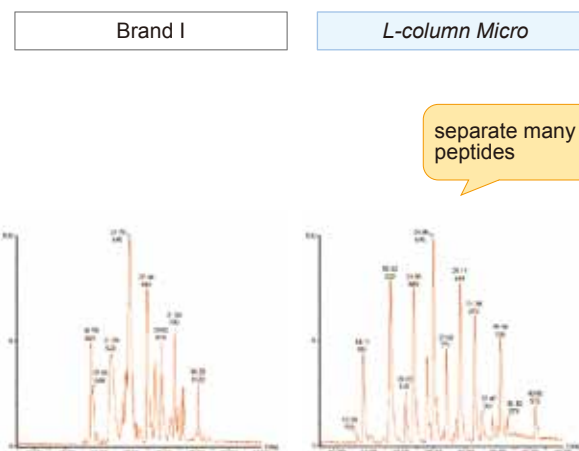

Trap column

In proteomic analysis using LC/MS/MS, the trap column is indispensable for increasing the injection volume. This trap column retains the target constituents firmly and its media has little irreversible adsorption of the target constituents. Therefore, the actual loss of target constituents is negligible. In the range of 20 - 1000 ng for the insulin B chain, a linear relationship is obtained between the injection volume and the peak area.

■ Insulin, chain B (20 - 1000 ng)

[Analytical conditions]
 Trap column: L-column ODS, 5 μm
 Size: 0.3 mm I.D., 5 mm L. (Cat.No.652450)
 Eluent: A: 0.1% HCOOH in CH_3CN ; B: 0.1% HCOOH in H_2O
 A/B, 5/95-40/60-90/10 (0-10-15 min)
 Detection: UV 215 nm; Inj.vol.: 1 μL

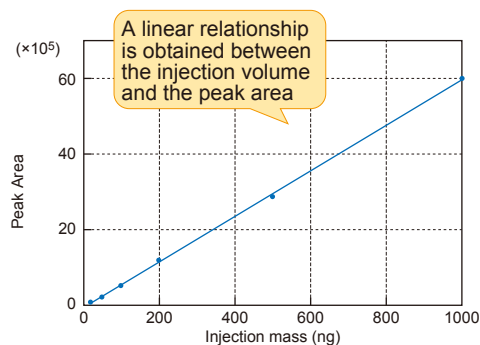

A small dead volume, low-adsorption property and high retention ability that traps target constituents are required effectively in a trap column.

L-column trap column does not decrease the theoretical plate number because of its very small dead volume. Not only that, because it is a cartridge-type trap column, it is more economical.

■ Tryptic digest of BSA (500 fmol)

[Analytical conditions]
 Column: L-column ODS, 3 μm
 Size: 0.075 mm I.D., 50 mm L.; Non-sleeved type (Cat.No.611380)
 Eluent: A: 0.1% HCOOH in CH_3CN ; B: 0.1% HCOOH in H_2O
 A/B, 5/95-40/60 (0-60 min)
 Flow rate: 0.25 - 0.3 $\mu\text{L}/\text{min}$
 Detection: UV 215 nm; Inj.vol.: 1 μL

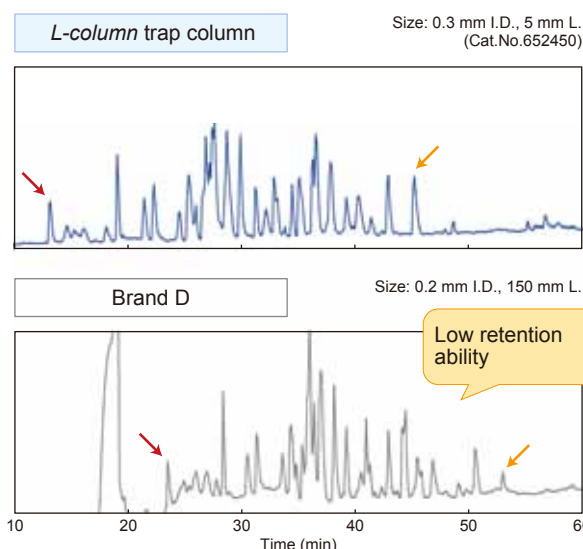

Cartridge trap column (0.3 mm I.D., 5 mm L.)
 Particle size: 5 μm

L-column ODS

Established, high-performance standard C18 column.

In 1990, *L-column ODS* was introduced as a column whose secondary interaction with the residual silanol groups was eliminated by a new end-capping method using high-temperature silylation. At the time, the performance of *L-column ODS* was far superior to that of existing C18 columns, and it became a pioneer of the new-generation end-capping method.

Properties

Particle size	3 μm , 5 μm
Pore size	12 nm
Surface area	340 m ² /g
Carbon contents	17%
Bonded phase	Octadecyl silyl (C18, ODS)
End-capping	High temperature gas phase end-capping
USP category	L 1
Usable pH range	pH 2 - pH 9



Comparison between *L-column ODS* and other columns

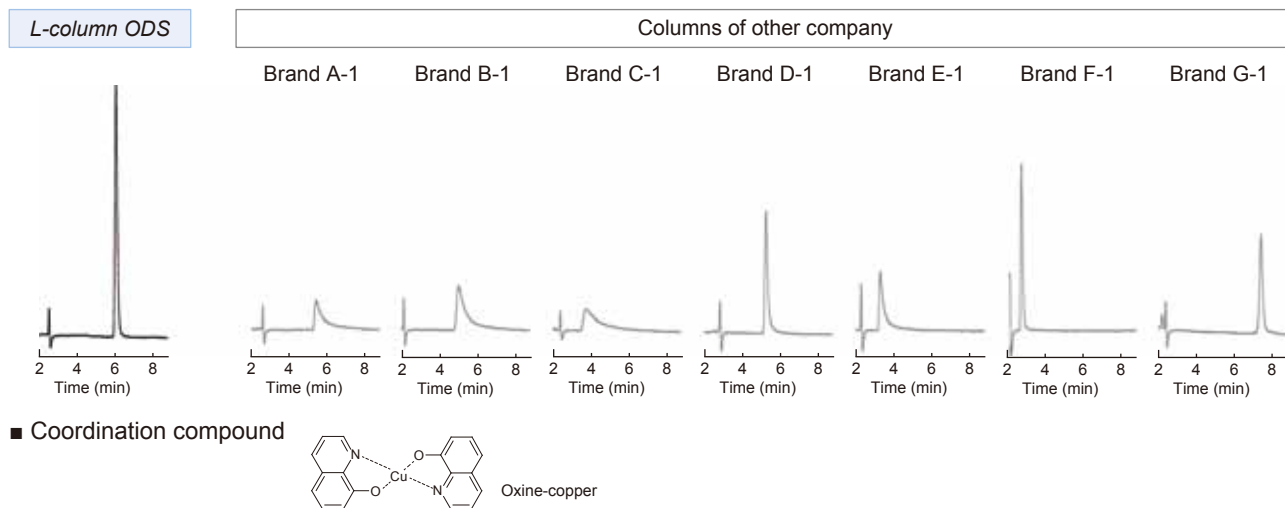
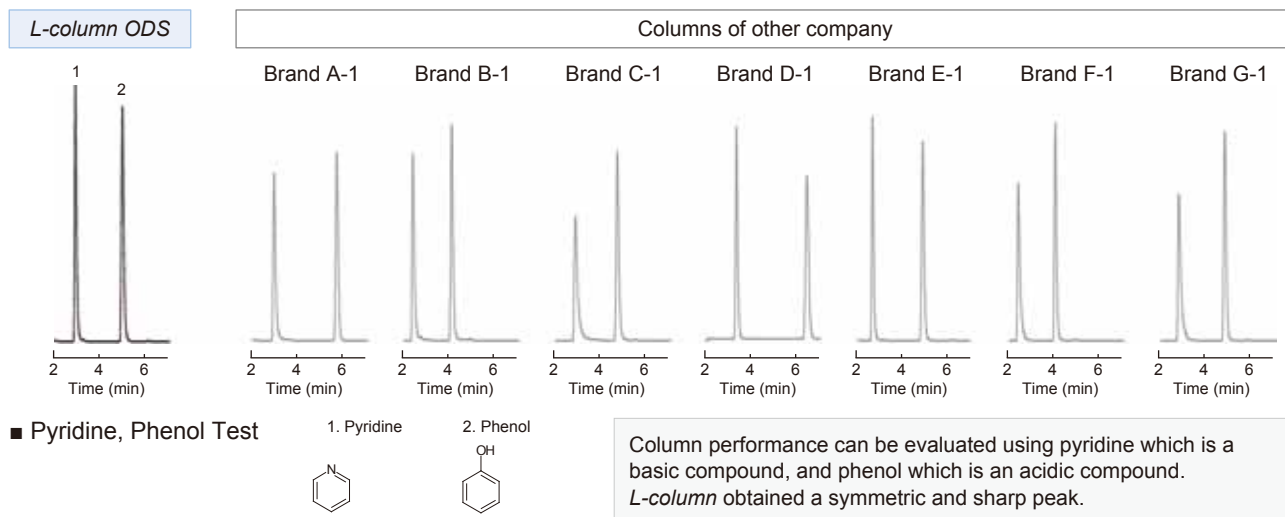

[Analytical conditions]
 Column: C18, 3 μm
 Size: 2 mm I.D. or 2.1 mm I.D., 150 mm L.

L-column ODS-P Wide pore C18 column for analysis of protein and peptide.

L-column ODS-P is ideal for the analysis of proteins and peptides. The base silica has a pore diameter of 30 nm. Adsorption is minimized and proteins and peptides elute with sharp peaks. Biological samples are often analyzed using TFA in the eluent and L-column ODS-P is exceptionally stable in strongly acidic eluent.

Properties

Particle size	5 μm
Pore size	30 nm
Surface area	150 m^2/g
Carbon contents	9%
Bonded phase	Octadecyl silyl (C18, ODS)
End-capping	High temperature gas phase end-capping
USP category	L 1
Usable pH range	pH 2 - pH 9

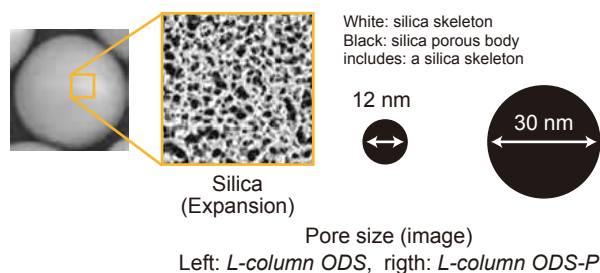

Role of Pore diameter in protein and peptide analysis

A molecular weight of under 10000 does not show different peak shape between 12 nm pore diameter and 30 nm pore diameter. On the other hand, a molecular weight of over 10000 shows a broad peak when analyzed on the 12 nm L-column ODS and the main component is not separated from the impurities. Using 30 nm L-column ODS-P, the main component is separated from the impurities with good peak shape.

Analytes of molecular weight of approximately 10,000 to 20,000 are suitable for L-column ODS-P.

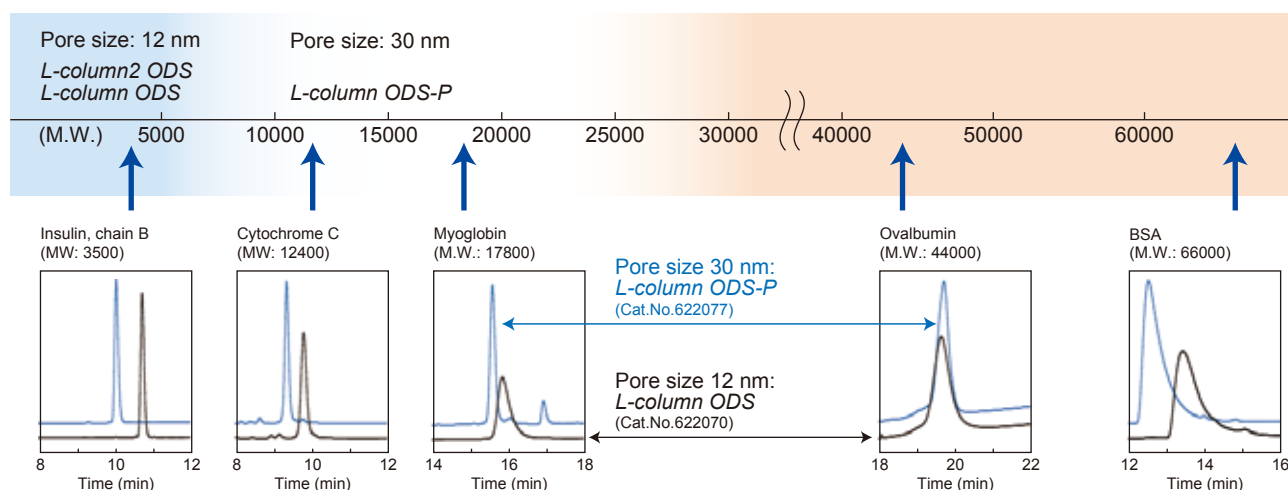

■ Peptides, Proteins

[Analytical conditions]
Column: C18, 5 μm
Size: 4.6 mm I.D., 150 mm L.
Eluent: A: 0.1% TFA in CH_3CN ; B: 0.1% TFA in H_2O
A/B, 25/75-60/40-60/40 (0-20-25 min)
Flow rate: 1 mL/min
Temp.: 25 $^\circ\text{C}$; Detection: UV 220 nm; Inj. vol.: 10 μL

The retention of high molecular weight proteins such as ovalbumin and BSA is less because they are hydrophobic interactions only on the stationary phase (ODS) surface.

L-column C8

high-performance standard octyl column.

L-column C8 is end-capped using the same advanced method used for L-column ODS. L-column C8 is most suitable for reducing the analysis time of hydrophobic compounds and conserving solvent.

Properties

Particle size	5 μm
Pore size	12 nm
Surface area	340 m^2/g
Carbon contents	10%
Bonded phase	Octyl silyl (C8)
End-capping	High temperature gas phase end-capping
USP category	L 7
Usable pH range	pH 2 - pH 7.5



Antihistamines

[Analytical conditions]
 Column: 5 μm
 Size: 4.6 mm I.D., 150 mm L.
 Eluent: $\text{CH}_3\text{CN}/50$ mM Phosphate buffer pH 6.8 (43/57)
 Flow rate: 1 mL/min
 Temp.: 40 $^\circ\text{C}$; Detection: 220 nm; Inj. vol.: 1 μL

1. Chlorpheniramine

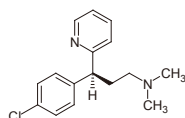

2. Diphenhydramine

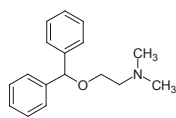

3. Clemastine

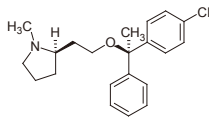

I.S. n-Butyl p-hydroxybenzoate

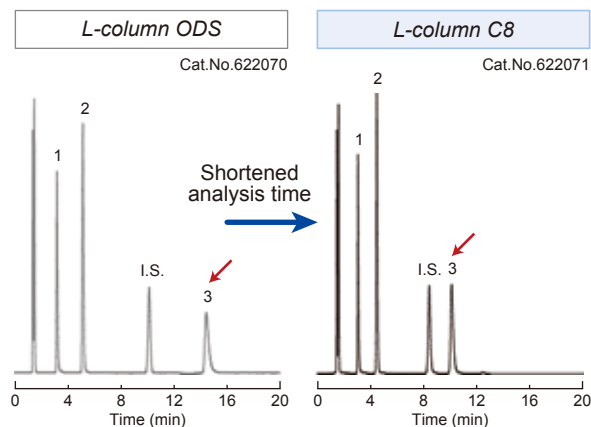
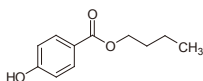

Sulfa drugs

[Analytical conditions]
 Column: 5 μm
 Size: 4.6 mm I.D., 150 mm L.
 Eluent: $\text{CH}_3\text{OH}/50$ mM $\text{CH}_3\text{COONH}_4$ in H_2O (15/85)
 Flow rate: 1 mL/min
 Temp.: 40 $^\circ\text{C}$; Detection: 270 nm; Inj. vol.: 15 μL
 Sample: 1. Sulfadiazine; 2. Sulfisomidine; 3. Sulfathiazole;
 4. Sulfamethoxazole; 5. Sulfamerazine;
 6. Sulfamonomethoxine; 7. Sulfadoxine;
 8. Sulfamethoxypyridazine; 9. Sulfadimidine;
 10. Sulfadimethoxine; 11. Sulfaquinoxaline

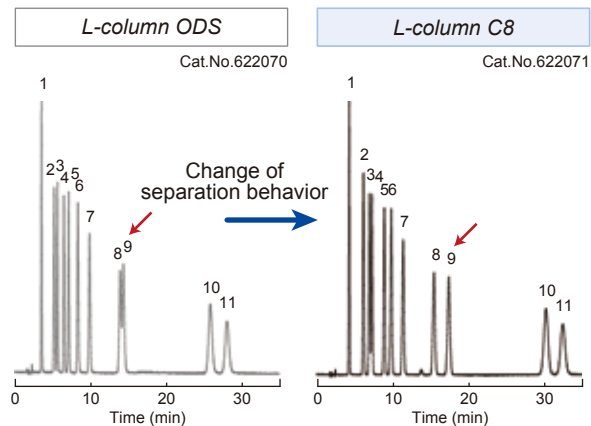

Line up *L-column*

Packing materials	Particle size	Inner diameter	Length								
			30 mm	35 mm	50 mm	75 mm	100 mm	150 mm	250 mm		
<i>L-column ODS</i> (USP category: L 1)	3 μ m	1.5 mm	Cat.No.			611130		611160	611010		
		2.1 mm	Cat.No.	611630	611240	611140	611640	611170	611020	611220	
		3.0 mm	Cat.No.	621650		621490	621600	621330	621260	621320	
			Price (JPY)								
		4.6 mm	Cat.No.		621250	621150	621460	621180	621070	621080	
			Price (JPY)								
		20.0 mm	Cat.No.			641230					
			Price (JPY)								
		5 μ m	1.5 mm	Cat.No.			612130		612160	612010	
	2.1 mm		Cat.No.		612240	612140		612170	612020	612220	
	3.0 mm		Cat.No.					622330	622260	622320	
			Price (JPY)								
	4.0 mm		Cat.No.							622040	622310
4.6 mm	Cat.No.			622250	622150		622180	622070	622080		
		Price (JPY)									
		6.0 mm	Cat.No.					622090			
			Price (JPY)								
		10.0 mm	Cat.No.						642100		
			Price (JPY)								
		20.0 mm	Cat.No.			642230		642520	642120		
			Price (JPY)								
<i>L-column ODS-P</i> (USP category: L 1)	5 μ m	1.5 mm	Cat.No.			612137		612167	612017		
		2.1 mm	Cat.No.		612247	612147		612177	612027	612227	
		3.0 mm	Cat.No.						622267	622327	
		Price (JPY)									
	4.6 mm	Cat.No.		622257	622157		622187	622077	622087		
		Price (JPY)									
<i>L-column C8</i> (USP category: L 7)	5 μ m	1.5 mm	Cat.No.			612131		612161	612011		
		2.1 mm	Cat.No.		612241	612141		612171	612021	612221	
		3.0 mm	Cat.No.						622261	622321	
			Price (JPY)								
		4.6 mm	Cat.No.		622251	622151		622181	622071	622081	
	Price (JPY)										

- Connection type: 1/16" Waters.

Line up *L-column2*Packing materials: *L-column2* ODS (USP category: L 1)

Particle size	Inner diameter	Cat.No.	Length								
			10 mm	20 mm	30 mm	35 mm	50 mm	75 mm	100 mm	150 mm	250 mm
2 μ m	1.5 mm	Cat.No.						713160	713010		
	2.1 mm	Cat.No.	713780	713770	713630		713140	713640	713170	713020	
		Price (JPY)									
	3.0 mm	Cat.No.			723650		723490	723600	723330		
		Price (JPY)									
3 μ m	1.5 mm	Cat.No.					711130		711160	711010	
	2.1 mm	Cat.No.	711780	711770	711630	711240	711140	711640	711170	711020	711220
	3.0 mm	Cat.No.			721650		721490	721600	721330	721260	721320
		Price (JPY)									
	4.6 mm	Cat.No.				721250	721150	721460	721180	721070	721080
		Price (JPY)									
	20.0 mm	Cat.No.					741230				
		Price (JPY)									
5 μ m	1.5 mm	Cat.No.					712130		712160	712010	
	2.1 mm	Cat.No.				712240	712140		712170	712020	712220
	3.0 mm	Cat.No.							722330	722260	722320
		Price (JPY)									
	4.0 mm	Cat.No.								722040	722310
	4.6 mm	Cat.No.				722250	722150		722180	722070	722080
		Price (JPY)									
	6.0 mm	Cat.No.								722090	
		Price (JPY)									
	10.0 mm	Cat.No.								742510	742100
		Price (JPY)									
	20.0 mm	Cat.No.					742230			742520	742120
	Price (JPY)										

- Connection type: 1/16" Waters.

Packing materials: *L-column2* C8 (USP category: L 7)

Particle size	Inner diameter	Cat.No.	Length								
			10 mm	20 mm	30 mm	35 mm	50 mm	75 mm	100 mm	150 mm	250 mm
3 μ m	1.5 mm	Cat.No.					711131		711161	711011	
	2.1 mm	Cat.No.	711781	711771	711631	711241	711141	711641	711171	711021	711221
	3.0 mm	Cat.No.			721651		721491	721601	721331	721261	721321
		Price (JPY)									
	4.6 mm	Cat.No.				721251	721151	721461	721181	721071	721081
		Price (JPY)									
5 μ m	1.5 mm	Cat.No.					712131		712161	712011	
	2.1 mm	Cat.No.				712241	712141		712171	712021	712221
	3.0 mm	Cat.No.							722331	722261	722321
		Price (JPY)									
	4.6 mm	Cat.No.				722251	722151		722181	722071	722081
		Price (JPY)									

- Connection type: 1/16" Waters.

Line up *L-column2*

Packing materials: *L-column2* C6-Phenyl (USP category: L 11)

Particle size	Inner diameter	Length									
		10 mm	20 mm	30 mm	35 mm	50 mm	75 mm	100 mm	150 mm	250 mm	
3 μ m	1.5 mm	Cat.No.				711136		711166	711016		
	2.1 mm	Cat.No.	711786	711776	711636	711246	711146	711646	711176	711026	711226
	3.0 mm	Cat.No.			721656		721496	721606	721336	721266	721326
		Price (JPY)									
	4.6 mm	Cat.No.				721256	721156	721466	721186	721076	721086
5 μ m	1.5 mm	Cat.No.				712136		712166	712016		
	2.1 mm	Cat.No.				712246	712146	712176	712026	712226	
	3.0 mm	Cat.No.							722266	722326	
		Price (JPY)									
	4.6 mm	Cat.No.				722256	722156		722186	722076	722086
	Price (JPY)										

- Connection type: 1/16" Waters.

Metal-free column

Packing materials	Particle size	Inner diameter	Length					
			30 mm	50 mm	100 mm	150 mm	250 mm	
<i>L-column2</i> ODS (USP category: L 1)	3 μ m	2.0 mm	Cat.No.	731630	731140	731170	731020	731220
			Price (JPY)					
	5 μ m	2.0 mm	Cat.No.		732140	732170	732020	732220
			Price (JPY)					
<i>L-column2</i> C8 (USP category: L 7)	3 μ m	2.0 mm	Cat.No.	731631	731141	731171	731021	731221
			Price (JPY)					
	5 μ m	2.0 mm	Cat.No.		732141	732171	732021	732221
			Price (JPY)					
<i>L-column2</i> C6-Phenyl (USP category: L 11)	3 μ m	2.0 mm	Cat.No.	731636	731146	731176	731026	731226
			Price (JPY)					
	5 μ m	2.0 mm	Cat.No.		732146	732176	732026	732226
			Price (JPY)					

- Connection type: 1/16" Waters.



L-column2 Metal-free column

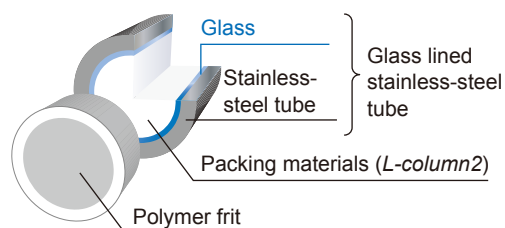

L-column2 metal free columns are improved the peak shape, carryover and S/N in the analysis of proteins, peptides and coordination compounds.

Line up

L-column Micro: Nano column / micro column with 0.075 mm I.D. - 0.3 mm I.D.

Packing materials	Inner diameter	Cat.No.	Length						
			Particle size: 2 μ m		Particle size: 3 μ m			Particle size: 5 μ m	
			50 mm	150 mm	50 mm	150 mm	500 mm	50 mm	150 mm
<i>L-column2 ODS</i> (USP category: L 1)	0.075 mm	Cat.No.			711410	711420	711800	712410	712420
	0.1 mm	Cat.No.			711390	711400	711810	712390	712400
	0.2 mm	Cat.No.	713290	713300	711290	711300		712290	712300
	0.3 mm	Cat.No.	713270	713280	711270	711280		712270	712280
			Price (JPY)						
<i>L-column2 C8</i> (USP category: L 7)	0.075 mm	Cat.No.			711411	711421		712411	712421
	0.1 mm	Cat.No.			711391	711401		712391	712401
	0.2 mm	Cat.No.			711291	711301		712291	712301
	0.3 mm	Cat.No.			711271	711281		712271	712281
			Price (JPY)						
<i>L-column2 C6-Phenyl</i> (USP category: L 11)	0.075 mm	Cat.No.			711416	711426		712416	712426
	0.1 mm	Cat.No.			711396	711406		712396	712406
	0.2 mm	Cat.No.			711296	711306		712296	712306
	0.3 mm	Cat.No.			711276	711286		712276	712286
			Price (JPY)						
<i>L-column ODS</i> (USP category: L 1)	0.075 mm	Cat.No.			611410	611420		612410	612420
	0.1 mm	Cat.No.			611390	611400		612390	612400
	0.2 mm	Cat.No.			611290	611300		612290	612300
	0.3 mm	Cat.No.			611270	611280		612270	612280
			Price (JPY)						
<i>L-column ODS-P</i> (USP category: L 1)	0.075 mm	Cat.No.						612417	612427
	0.1 mm	Cat.No.						612397	612407
	0.2 mm	Cat.No.						612297	612307
	0.3 mm	Cat.No.						612277	612287
			Price (JPY)						

- Connection type: 1/16" Valco type.

Line up

Guard column, Trap column (cartridge type)

Packing materials	Particle size	Inner diameter	Length	Specification	Cat.No.	Price (JPY)
<i>L-column2 ODS</i>	5 μm	0.3 mm	5 mm	Cartridge (3 pcs)	752450	
		2.0 mm	5 mm	Cartridge (3 pcs)	752330	
		4.6 mm	10 mm	Cartridge (3 pcs)	752050	
<i>L-column2 C8</i>	5 μm	0.3 mm	5 mm	Cartridge (3 pcs)	752453	
		2.0 mm	5 mm	Cartridge (3 pcs)	752333	
		4.6 mm	10 mm	Cartridge (3 pcs)	752053	
<i>L-column2 C6-Phenyl</i>	5 μm	0.3 mm	5 mm	Cartridge (3 pcs)	752456	
		2.0 mm	5 mm	Cartridge (3 pcs)	752336	
		4.6 mm	10 mm	Cartridge (3 pcs)	752056	
<i>L-column ODS</i>	5 μm	0.3 mm	5 mm	Cartridge (3 pcs)	652450	
		2.0 mm	5 mm	Cartridge (3 pcs)	652330	
		4.6 mm	10 mm	Cartridge (3 pcs)	652050	
<i>L-column ODS-P</i>	5 μm	0.3 mm	5 mm	Cartridge (3 pcs)	652457	
		2.0 mm	5 mm	Cartridge (3 pcs)	652337	
		4.6 mm	10 mm	Cartridge (3 pcs)	652057	
<i>L-column C8</i>	5 μm	0.3 mm	5 mm	Cartridge (3 pcs)	652453	
		2.0 mm	5 mm	Cartridge (3 pcs)	652333	
		4.6 mm	10 mm	Cartridge (3 pcs)	652053	
Holder	Direct type	For 2.0 mm I.D.		(1 pc)	651332	
		For 4.6 mm I.D.		(1 pc)	651052	
	Non-direct type	For 0.3 mm I.D.		(1 pc)	652452	
		For 2.0 mm I.D.		(1 pc)	652332	
		For 4.6 mm I.D.		(1 pc)	652052	

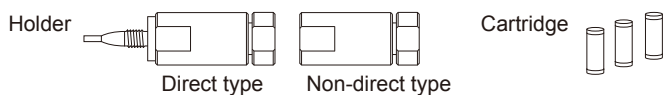

Pre-column filter

Specification	Cat.No.	Price (JPY)
Filter (1 pc), holder W+W (1 pc) Connection type: Column side, Waters type; LC tubing side, Waters type	653002	
Filter (1 pc), holder W+U (1 pc) Connection type: Column side, Waters type; LC tubing side, UPLC® type	653004	
Filter (5 pcs) For replacement	653003	

Tube of LC system
stainless-steel nut

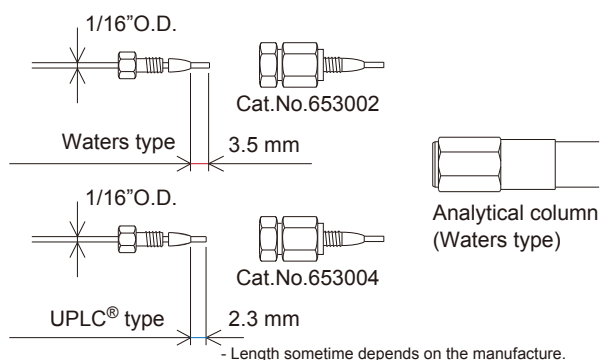

* Length sometime depends on the manufacture.

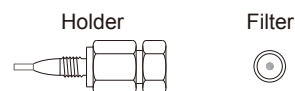

The pre-column filter prevents shavings generated from the plunger seal, insoluble matters in samples, etc., from entering the column. The pre-column filter is indispensable for maintaining column longevity. The theoretical plate number does not decrease when attaching L-column pre-column filter because its direct connection with the analytical column prevents the generation of a dead volume.

L-column pre-column filter can be installed on most HPLC systems because it has two types, Waters and UPLC®.

LC column catalog
L-column, L-column2

Chemicals Evaluation and Research Institute, Japan

- The product specifications are as of January 1, 2020. Please note that they may be changed without prior notice.
- For questions about part prices or ordering, please contact the Chromatography Department of CERI or a nearby agency. Details are provided on the page for the Chromatography Department of our website. Please use them as a reference.

CERI

一般財団法人 化学物質評価研究機構
Chemicals Evaluation and Research Institute, Japan

<https://www.cerij.or.jp>



**CERI Tokyo
Chromatography department**

e-mail chromato@ceri.jp

FAX +81-480-37-2521

1600 Shimotakano, Sugito-machi, Kitakatsushika-gun,
Saitama 345-0043, Japan