

# LC column catalog

# L-column3

L-column3, Super performance column for LC, Since 2017.

L-column3

Ver. 02

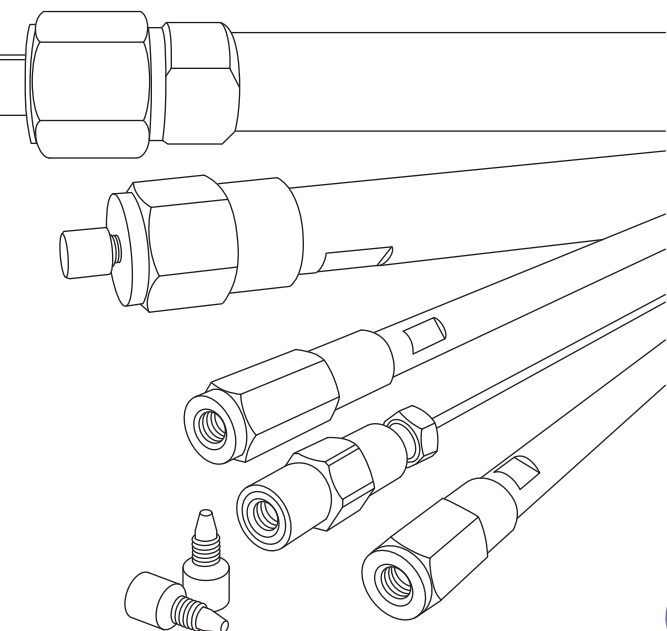

L-column3

- Feature
- UHPLC column
- Metal-free column
- Application data
- Technical report
- Line up

L-column, L-column2

- Feature
- Line up

*Realizing both excellent chemical stability  
and top-level low adsorptivity  
Unparalleled high-performance, all-around column*

# L-column 3

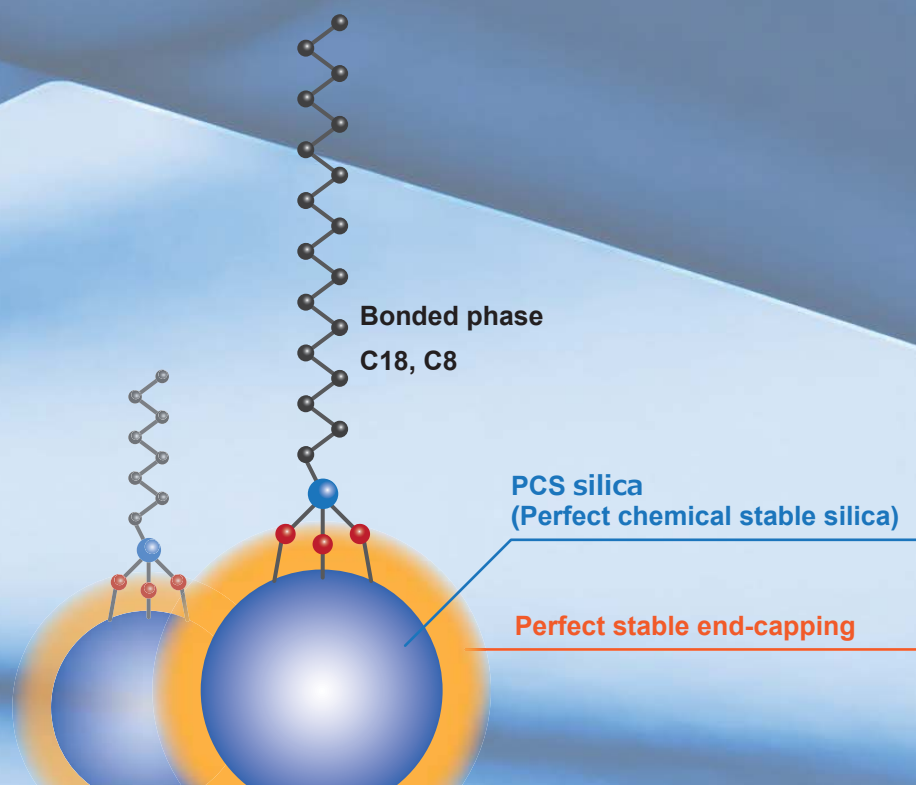

- Improving chemical stability, so that usable within the range of pH 1 to pH 12.
- Low adsorptivity is at the top level for various analytes.
- Improvement of separation or peak shape, since the pH of an eluent is flexibly selectable
- A 100% aqueous eluent can be stably analyzed.

Silica-based columns with the many advantages of high separation efficiency and mechanical strength are currently used most generally for the columns for reversed phase chromatography. On the other hand, the pH range of usable eluent is limited because exposure to the alkaline solution are easily dissolved silica.

*L-column3* is an all-around column where the chemical stability (acid and alkaline resistance) of the packing materials is dramatically improved by using newly developed and highly alkaline resistant [PCS silica \(perfect chemical stable silica\)](#) and [perfectly stable end-capping](#) with performance much higher than that of *L-column2*.

## ***L-column3* proposes the possibility of a new analysis.**



	<i>L-column3 C18</i>	<i>L-column3 C8</i>
Base materials	PCS silica (Perfect chemical stable silica)	
Pore size	12 nm	
Specific surface area	340 m <sup>2</sup> /g	
Particle size	2 μm, 3 μm, 5 μm	3 μm, 5 μm
Bonded phase	Octadecyl silyl (C18, ODS)	Octyl silyl (C8, Octyl)
End-capping	Perfect stable end-capping	
USP category	L 1	L 7
Usable pH range	pH 1 - pH 12	

## L-column3 is chemically stable, so that usable within the range of pH 1 to pH 12.

L-column3 offers very high resistance to alkaline, and packing materials are designed to be robust. In addition, it performs similar high resistance to neutrality and acidity.

L-column3 can be used as an all-around column capable of method design for a wide range of pH values.

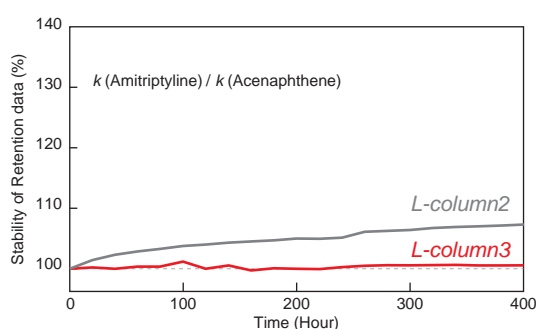
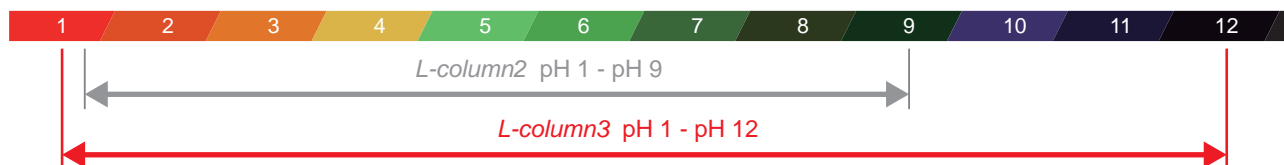

### ■ Durability test (pH 1)

[Durability test conditions]  
Column: C18, 5  $\mu\text{m}$ ; Size: 2.1 mm I.D., 150 mm L.  
Eluent:  $\text{CH}_3\text{OH}/1\% \text{ TFA in H}_2\text{O}$  (10/90)  
Flow rate: 0.2 mL/min; Temp.: 40°C

-  $k$ : Retention factor

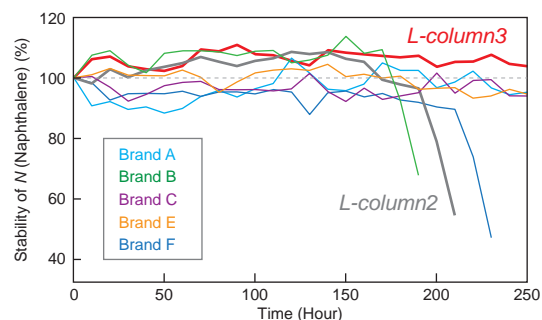
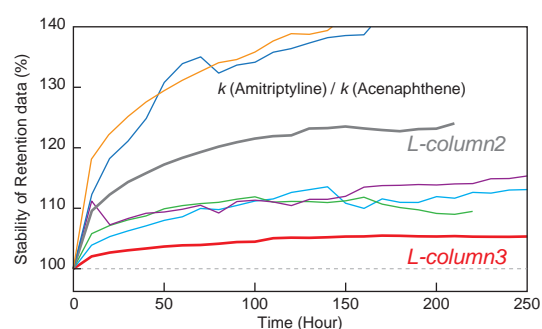
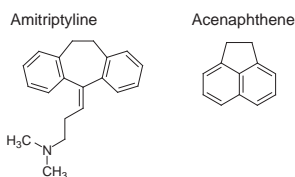

### ■ Durability test (pH 12, triethylamine solution)

[Durability test conditions]  
Column: C18, 5  $\mu\text{m}$ ; Size: 2.0 mm or 2.1 mm I.D., 150 mm L.  
Eluent:  $\text{CH}_3\text{OH}/54 \text{ mM TEA in H}_2\text{O}$  (10/90)  
Flow rate: 0.2 mL/min; Temp.: 50°C

-  $k$ : Retention factor,  $N$ : Number of theoretical plates

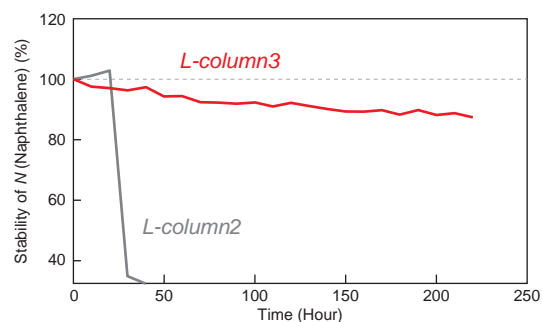

### ■ Durability test (pH 12, phosphate buffer solution)

[Durability test conditions]  
Column: C18, 5  $\mu\text{m}$ ; Size: 2.1 mm I.D., 150 mm L.  
Eluent:  $\text{CH}_3\text{OH}/10 \text{ mM Phosphate buffer}$  (10/90)  
Flow rate: 0.2 mL/min; Temp.: 40°C

-  $N$ : Number of theoretical plates

An alkaline eluent promotes the degradation of silica-based columns. The dissolution of silica adds vacant space to the column bed and decreases the number of theoretical plates. The loss of the bonded phase and exposure of the silanol group over the surface of silica cause adsorption of basic compounds into the silanol group, which results in a delay of retention (see the technical report on P. 11). A strong acid eluent is also subject to similar degradation, although the change is slow.

L-column3 shows small changes and is stable in durability tests at pH 1 and pH 12 (triethylamine solution and phosphate buffer solution).

Comparison columns are as follows:

- Columns of other company: Usable up to pH 12.
- L-column2: Usable from pH 1 to pH 9.

## Low adsorptivity is at the top level in various analytes.

L-column3 shows a sharp peak not only for basic compounds but also for acidic compounds and coordination compounds. L-column3 demonstrates low adsorptivity at the top level for various analytes and provides an ideal peak shape.

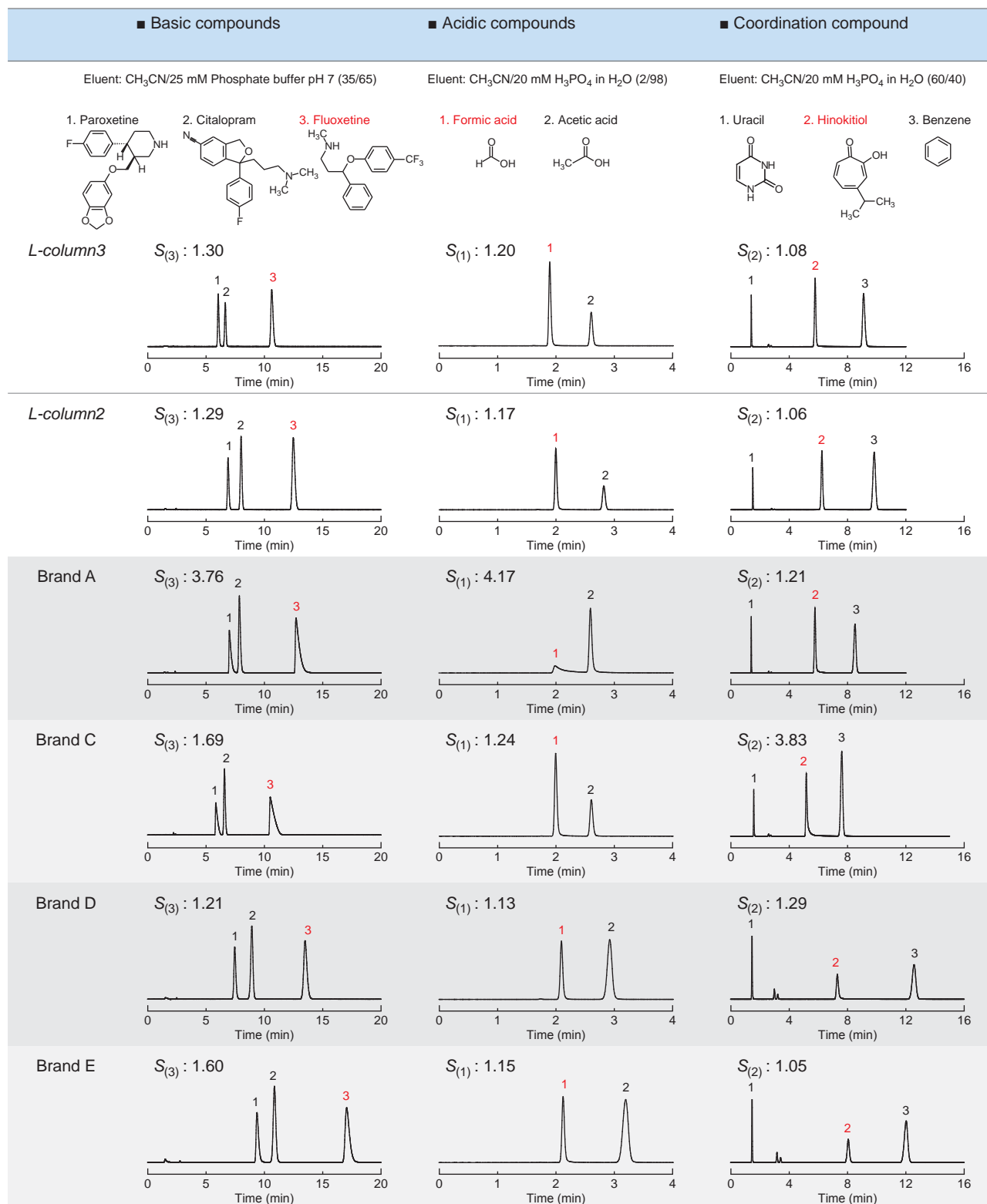

[Analytical conditions] Column: C18, 5  $\mu$ m; Size: 4.6 mm I.D., 150 mm L.; Flow rate: 1 mL/min; Temp.: 40°C; Inj. vol.: 1  $\mu$ L

- S : Symmetry factor

## Improvement of separation and peak shape, since the pH of an eluent is flexibly selectable.

Widening of the pH range of a usable eluent remarkably enlarges the range of the method of analysis. The use of an alkaline eluent, especially, enables analyses where the dissociation of basic compounds is restricted, which is very advantageous.

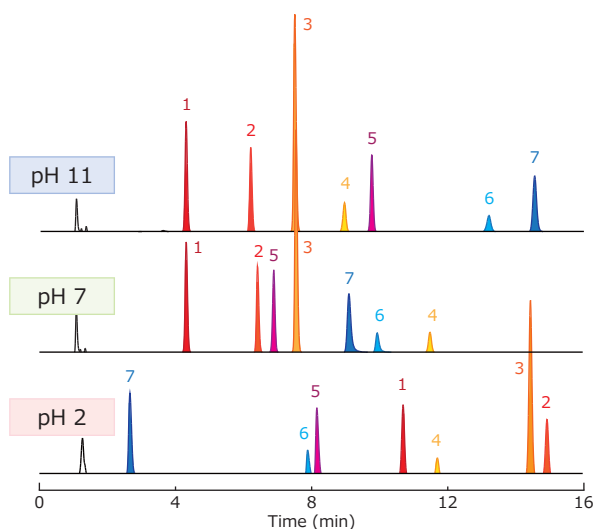

### Comparison of retention time (Drugs)

[Analytical conditions]  
 Column: L-column3 C18, 5  $\mu$ m; Size: 2.1 mm I.D., 150 mm L.  
 Eluent: A: CH<sub>3</sub>CN, B: 25 mM Phosphate buffer  
 A/B, 20/80-70/30 (0-20 min)  
 Flow rate: 0.3 mL/min; Temp.: 40°C; Detection: UV 220 nm  
 Inj. vol.: 1  $\mu$ L

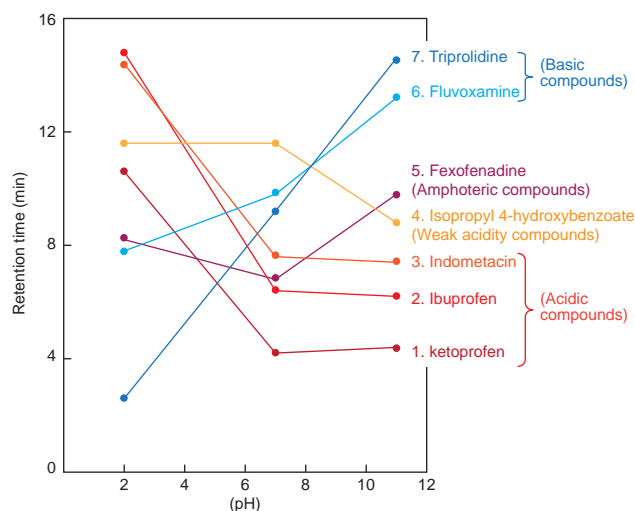

- The polygonal line graph is showed the retention behavior. Actually, retention time never linearly changes because of the existence of the buffer capacity or the influence of the buffer salt.

The change in the pH of an eluent changes the retention behavior of ionic compounds. Generally, for acidic compounds, higher pH results in less retention. Conversely, in basic compounds, higher pH results in greater retention. There is a strong possibility that the use of an alkaline eluent provides a separation pattern different from the acidity and neutral ranges, thus an improvement in separation can be expected.

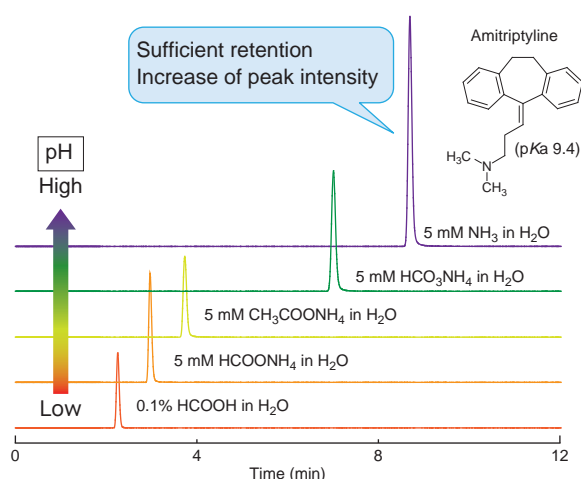

### Comparison of retention time (Basic drugs)

[Analytical conditions]  
 Column: L-column3 C18, 5  $\mu$ m; Size: 2.1 mm I.D., 150 mm L.  
 Eluent: A: CH<sub>3</sub>CN, B: Aqueous solution  
 A/B, 40/60-90/10-90/10 (0-10-12 min)  
 Flow rate: 0.3 mL/min; Temp.: 40°C; Detection: ESI-MS/MS (+)  
 Inj. vol.: 1  $\mu$ L

Peak intensity is important in the LC/MS often used in trace analysis. The high pH of an eluent in the analysis of basic compounds provides sufficient retention and peak intensity.

This is the advantage of the use of an alkaline eluent.



## The preparation efficiency of basic compounds is improved by using an alkaline eluent.

The use of an alkaline eluent remarkably improves the peak shape of basic compounds. Even a large injection volume does not cause deviations in the retention time but provides a sharp peak. Consequently, the increase in the loads becomes possible, and preparation efficiency is improved.

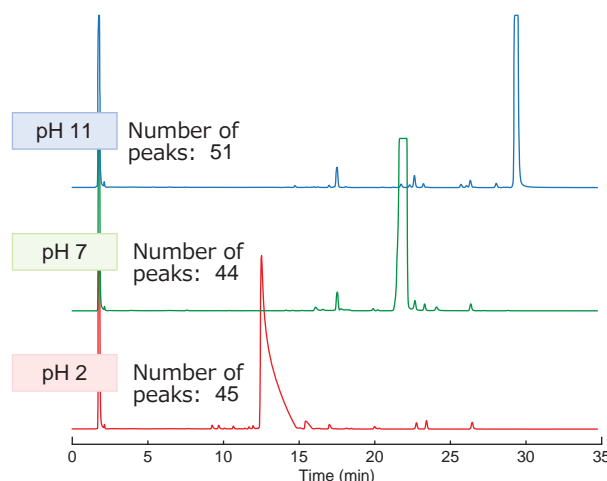
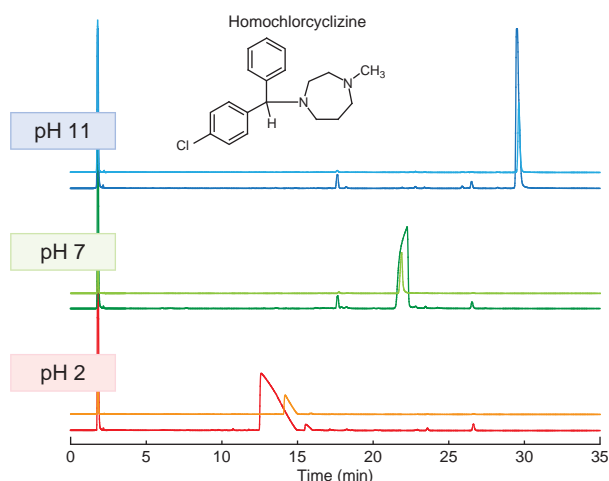

### ■ Comparison of injection volume (Basic drugs)

[Analytical conditions]  
Column: L-column3 C18, 5  $\mu$ m; Size: 2.1 mm I.D., 150 mm L.  
Eluent: A: CH<sub>3</sub>CN, B: 25 mM Phosphate buffer  
A/B, 5/95-75/25-75/25 (0-30-40 min)  
Flow rate: 0.2 mL/min; Temp.: 40°C; Detection: UV 240 nm  
Inj. vol.: upper: 0.5  $\mu$ L, lower: 5  $\mu$ L; Sample: Homochlorcyclizine

- The 10 g/L homochlorcyclizine added the hydrogen peroxide and left for 70 hours is used.

### ■ Comparison of the number of peaks (Basic drugs)

[Analytical conditions]  
Column: L-column3 C18, 5  $\mu$ m; Size: 2.1 mm I.D., 150 mm L.  
Eluent: A: CH<sub>3</sub>CN, B: 25 mM Phosphate buffer  
A/B, 5/95-75/25-75/25 (0-30-40 min)  
Flow rate: 0.2 mL/min; Temp.: 40°C; Detection: UV 220 nm  
Inj. vol.: 5  $\mu$ L; Sample: Homochlorcyclizine

- The 10 g/L homochlorcyclizine added the hydrogen peroxide and left for 70 hours is used.

### Alkaline eluent

10 mM HCOOH+NH<sub>3</sub> in H<sub>2</sub>O (pH 11)  
Inj. vol.: 20  $\mu$ L (20 g/L)

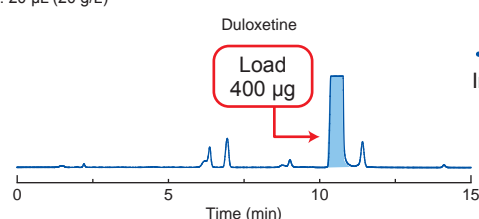

Scale-up  
Inner diameter of column  
Flow rate  
Injection volume  
Sample concentration

### Alkaline eluent

10 mM HCOOH+NH<sub>3</sub> in H<sub>2</sub>O (pH 11)  
Column Size: 10.0 mm I.D., 150 mm L.  
Flow rate: 4 mL/min  
Inj. vol.: 100  $\mu$ L (100 g/L)

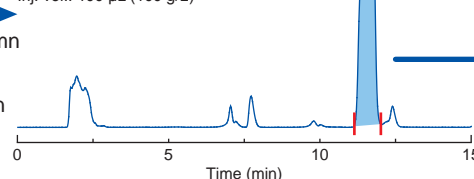

### Purity check:

Before purification 98.2%  
After purification >99.9%

Preparation

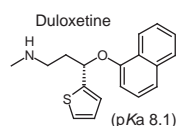

### Acidic eluent

10 mM HCOOH in H<sub>2</sub>O (pH 3)  
Inj. vol.: 10  $\mu$ L (1 g/L)

Load 10  $\mu$ g

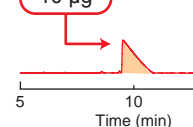

### Neutral eluent

10 mM HCOOH+NH<sub>3</sub> in H<sub>2</sub>O (pH 7)  
Inj. vol.: 2  $\mu$ L (20 g/L)

Load 40  $\mu$ g

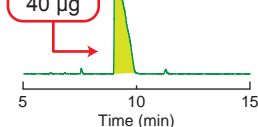

### ■ Preparative purification (Basic drugs)

[Analytical conditions]  
Column: L-column3 C18, 5  $\mu$ m; Size: 4.6 mm I.D., 150 mm L.  
Eluent: A: CH<sub>3</sub>CN, B: Aqueous solution  
A/B, Gradient elution  
Flow rate: 1 mL/min; Temp.: 40°C; Detection: UV 230 nm  
Sample: Duloxetine

The use of an alkaline eluent provides the following advantages in basic compounds:

- Load increases and preparation efficiency is improved
- Capable of preparation without counterion
- Improvement in the separation of the degradation product or impurities.

## A 100% aqueous eluent is available for stable analysis.

The deterioration of the silica-based column is promoted when used for a 100% aqueous eluent for a long period of time. Since the packing materials for *L-column3* have very high chemical stability, the column is stable for long periods of time even when used for the 100% aqueous eluent.

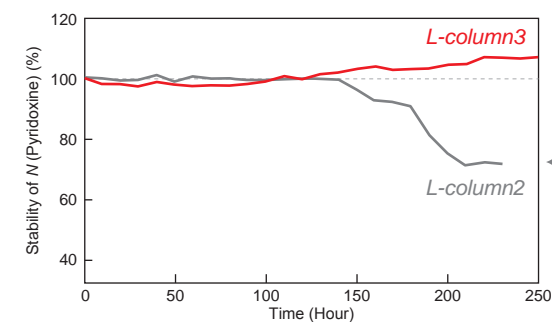

### ■ Durability test

[Durability test conditions]  
 Column: C18, 5  $\mu$ m; Size: 2.1 mm I.D., 150 mm L.  
 Eluent: 25 mM Phosphate buffer pH 7  
 Flow rate: 0.2 mL/min; Temp.: 50°C

- N: Number of theoretical plates

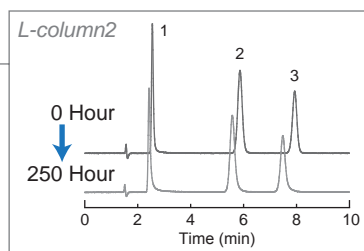
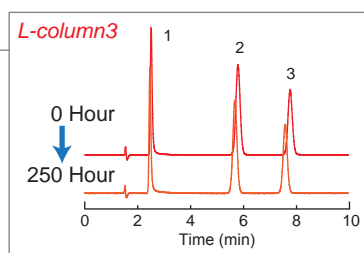

### ■ Vitamin B6

[Analytical conditions]  
 Column: C18, 5  $\mu$ m; Size: 2.1 mm I.D., 150 mm L.  
 Eluent: 25 mM Phosphate buffer pH 7  
 Flow rate: 0.2 mL/min; Temp.: 40°C; Detection: UV 320 nm  
 Inj. vol.: 1  $\mu$ L  
 Sample: 1. Pyridoxamine; 2. Pyridoxal; 3. Pyridoxine

## Application data

### L-column3 C8

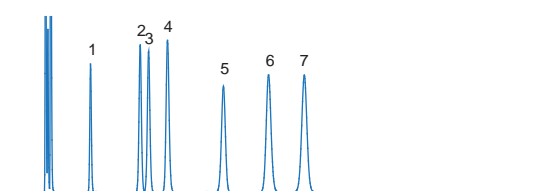

### L-column3 C18

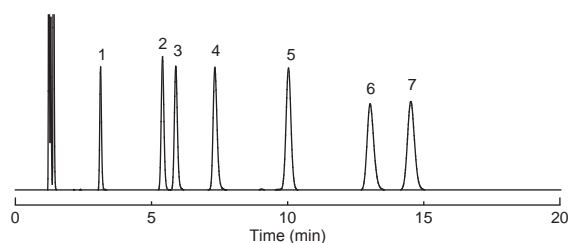

### ■ Antihistamine

[Analytical conditions]  
 Column: 5  $\mu$ m; Size: 4.6 mm I.D., 150 mm L.  
 Eluent: CH<sub>3</sub>CN/25 mM Phosphate buffer pH 7 (45/55)  
 Flow rate: 1 mL/min; Temp.: 40°C; Detection: UV 220 nm  
 Inj. vol.: 1  $\mu$ L  
 Sample: 1. Chlorpheniramine; 2. Diphenhydramine; 3. Diphenylpyraline  
 4. Homochlorcyclizine; 5. Hydroxyzine; 6. Clemastine  
 7. Promethazine

### Gradient elution

A: CH<sub>3</sub>CN, B: 25 mM Phosphate buffer pH 7, A/B, 0/100-10/90 (0-15 min)

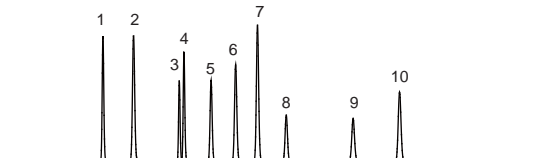

### Isocratic elution

25 mM Phosphate buffer pH 7

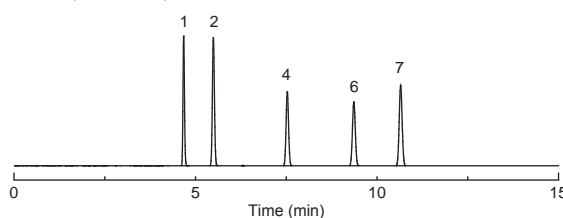

### ■ Nucleobase

[Analytical conditions]  
 Column: L-column3 C18, 5  $\mu$ m; Size: 4.6 mm I.D., 150 mm L.  
 Flow rate: 1 mL/min; Temp.: 40°C; Detection: UV 260 nm  
 Inj. vol.: upper: 2  $\mu$ L (50 mg/L), lower: 5  $\mu$ L (10 mg/L)  
 Sample: 1. Cytosine; 2. Uracil; 3. Cytidine; 4. Guanine; 5. Uridine  
 6. Thymine; 7. Adenine; 8. Guanosine; 9. Thymidine  
 10. Adenosine



## Application data

## Alkaline eluent

A: 5 mM  $\text{NH}_3$  in  $\text{CH}_3\text{OH}$   
B: 5 mM  $\text{NH}_3$  in  $\text{H}_2\text{O}$

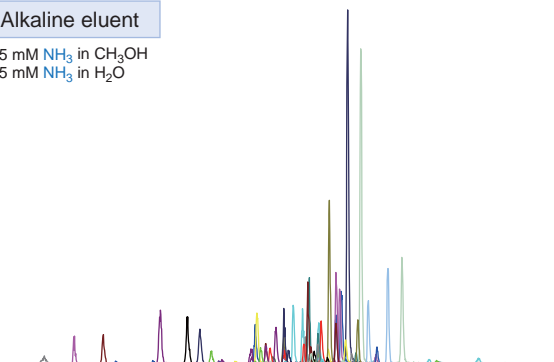

## Neutral eluent \*

A: 5 mM  $\text{CH}_3\text{COONH}_4$  in  $\text{CH}_3\text{OH}$   
B: 5 mM  $\text{CH}_3\text{COONH}_4$  in  $\text{H}_2\text{O}$

\* Simultaneous test method for pesticides by the LC/MS (agricultural products)

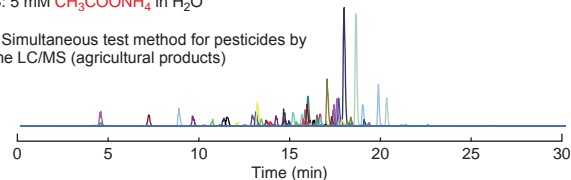

## Agricultural chemicals

[Analytical conditions]  
Column: *L-column3 C18*, 3  $\mu\text{m}$ ; Size: 2.1 mm I.D., 150 mm L.  
Eluent: A/B, 15/85-40/60-40/60-50/50-55/45-95/5-95/5  
(0-1-3.5-6-8-17.5-30 min)  
Flow rate: 0.2 mL/min; Temp.: 40°C; Detection: ESI-MS/MS (+)  
Inj. vol.: 5  $\mu\text{L}$  (50  $\mu\text{g/L}$ )

## Alkaline eluent

A:  $\text{CH}_3\text{CN}$   
B: 5 mM  $\text{NH}_3$  in  $\text{H}_2\text{O}$

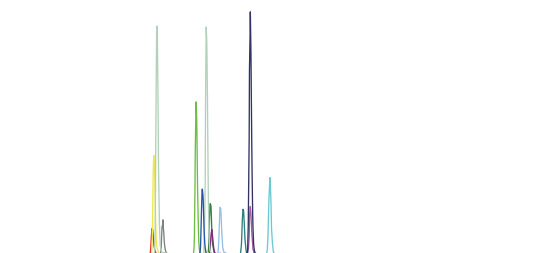

## Acidic eluent

A:  $\text{CH}_3\text{CN}$   
B: 5 mM  $\text{HCOOH}$  in  $\text{H}_2\text{O}$

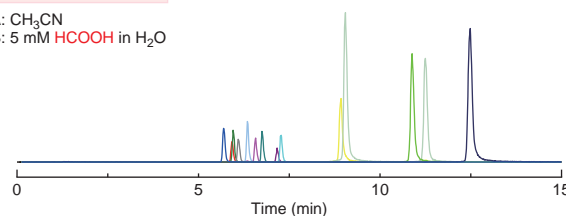

## Quinolones

[Analytical conditions]  
Column: *L-column3 C18*, 3  $\mu\text{m}$ ; Size: 2.1 mm I.D., 150 mm L.  
Eluent: A/B, 1/99-60/40  
(0-15 min)  
Flow rate: 0.3 mL/min; Temp.: 40°C; Detection: ESI-MS/MS (+)  
Inj. vol.: 1  $\mu\text{L}$  (50  $\mu\text{g/L}$ )

## pH 11

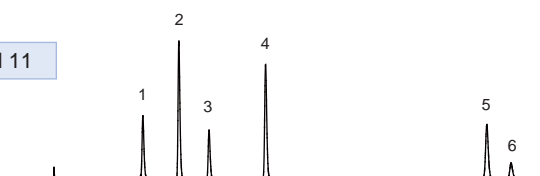

## pH 7

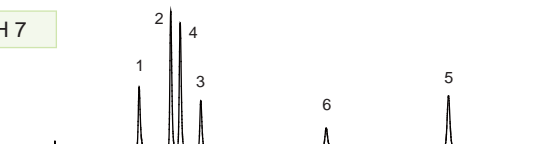

## pH 2

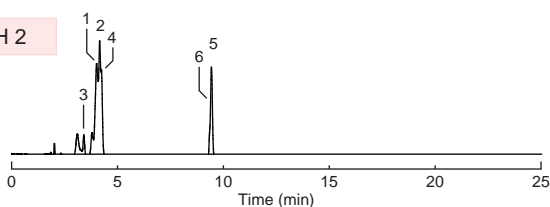
H<sub>2</sub> blocker

[Analytical conditions]  
Column: *L-column3 C18*, 5  $\mu\text{m}$ ; Size: 4.6 mm I.D., 150 mm L.  
Eluent: A:  $\text{CH}_3\text{CN}$ , B: 25 mM Phosphate buffer  
A/B, 5/95-50/50 (0-25 min)  
Flow rate: 1 mL/min; Temp.: 40°C; Detection: UV 230 nm  
Inj. vol.: 1  $\mu\text{L}$  (250 mg/L)  
Sample: 1. Famotidine; 2. Cimetidine; 3. Ranitidine; 4. Nizatidine  
5. Lafutidine; 6. Roxatidine

## Alkaline eluent

A:  $\text{CH}_3\text{CN}/5$  mM  $\text{NH}_3$  (95/5)  
B: 5 mM  $\text{NH}_3$  in  $\text{H}_2\text{O}$

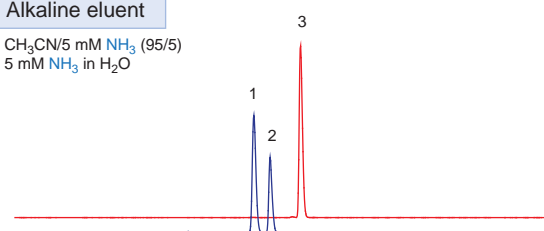

## Neutral eluent \*

A:  $\text{CH}_3\text{CN}/2$  mM  $\text{HCOONH}_4$ +50 mM  $\text{HCOOH}$  (95/5)  
B: 2 mM  $\text{HCOONH}_4$ +50 mM  $\text{HCOOH}$  in  $\text{H}_2\text{O}$

\* Department of Food Safety, Standards and Evaluation Division Notification 0306 No. 4 and Department of Food Safety, Standards Bureau, Inspection Division Notification 0306 No. 2

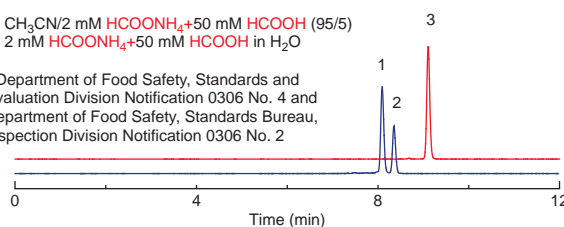

## Okadaic acids

[Analytical conditions]  
Column: *L-column3 C18*, 3  $\mu\text{m}$ ; Size: 2.1 mm I.D., 150 mm L.  
Eluent: A/B, 60/40-60/40-100/0-100/0  
(0-2.5-7.5-12.5 min)  
Flow rate: 0.2 mL/min; Temp.: 40°C; Detection: ESI-MS/MS (-)  
Inj. vol.: 5  $\mu\text{L}$   
Sample: 1. Okadaic acid; 2. Dinophysistoxin-2; 3. Dinophysistoxin-1

## UHPLC column

UHPLC (ultra-high performance liquid chromatography) is liquid chromatography provided at a higher speed with higher separation by using a column with fine particle packing materials in a particle size of about 2  $\mu\text{m}$ . *L-column3* with a wide selection range of pH values can select analytical conditions of detection sensitivity, peak shape, and elution order based on the intended purpose.

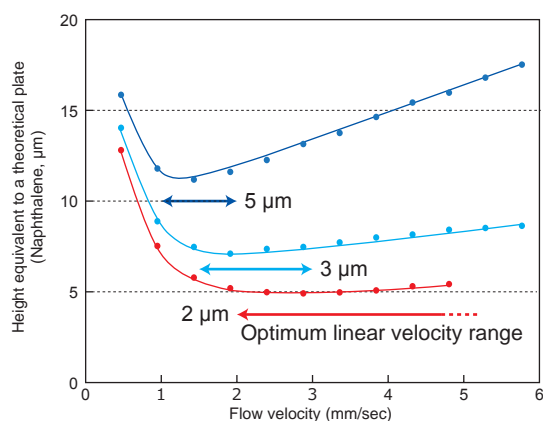
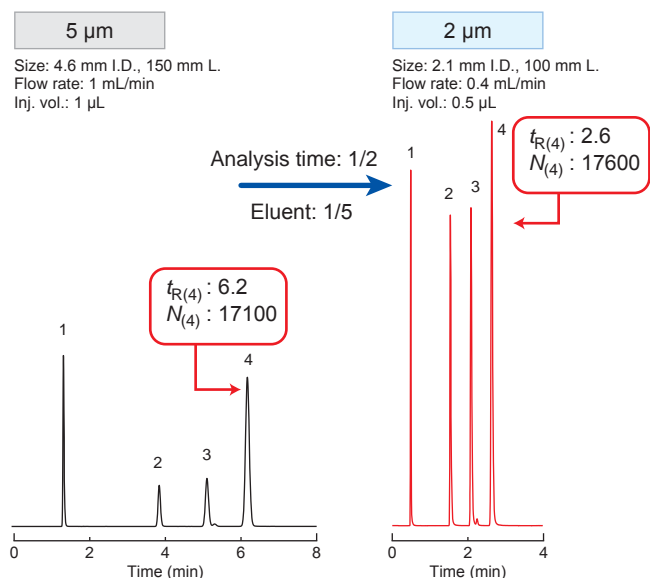

The decrease in particle size increases the linear velocity of the mobile phase (eluent) with height equivalent to a theoretical plate, and the change of that value is small within the wide range of the linear velocity. Therefore, UHPLC enables the analyses at a higher speed. In addition, the decrease of the inner diameter of the column and the length enables a reduction in the amount of eluent use.

***L-column* series (2  $\mu\text{m}$ ):**

- Optimum flow rate range of inner diameter 2.1 mm: approx. 0.4 mL/min
- Optimum flow rate range of inner diameter 3.0 mm: approx. 0.8 mL/min

## ■ Standard test

[Analytical conditions]  
Column: *L-column3 C18*  
Eluent:  $\text{CH}_3\text{CN}/\text{H}_2\text{O}$  (60/40); Temp.: 40°C; Detection: UV 254 nm  
Sample: 1. Uracil; 2. Benzene; 3. Toluene; 4. Naphthalene

-  $t_R$ : Retention time (min),  $N$ : Number of theoretical plates

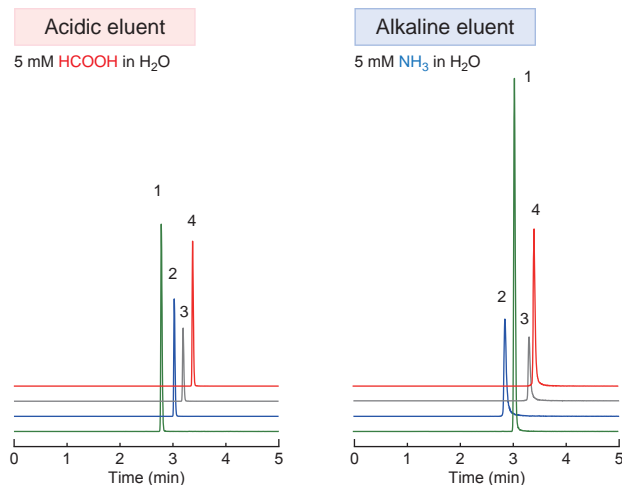

## ■ Antidepressants (SSRI)

[Analytical conditions]  
Column: *L-column3 C18*, 2  $\mu\text{m}$ ; Size: 2.1 mm I.D., 100 mm L.  
Eluent: A:  $\text{CH}_3\text{CN}$ , B: Aqueous solution  
A/B, 10/90-70/30 (0-5 min)  
Flow rate: 0.6 mL/min; Temp.: 40°C; Detection: ESI-MS/MS (+)  
Inj. vol.: 5  $\mu\text{L}$  (0.1 mg/L)  
Sample: 1. Citalopram; 2. Paroxetine; 3. Duloxetine; 4. Fluoxetine

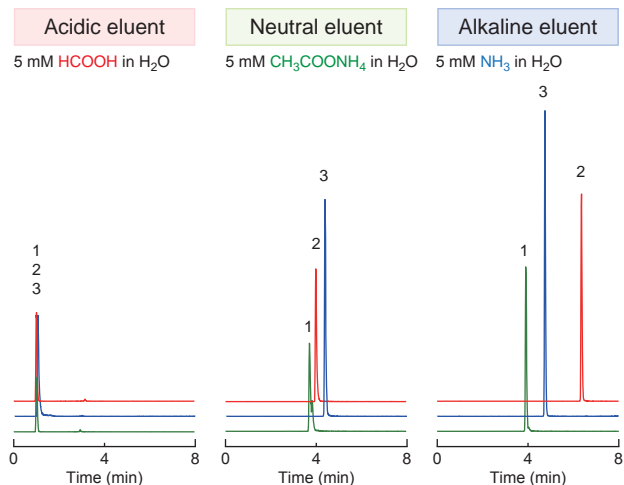
■  $\text{H}_2$  blocker

[Analytical conditions]  
Column: *L-column3 C18*, 2  $\mu\text{m}$ ; Size: 2.1 mm I.D., 100 mm L.  
Eluent: A:  $\text{CH}_3\text{CN}$ , B: Aqueous solution  
A/B, 0/100-50/50 (0-10 min)  
Flow rate: 0.3 mL/min; Temp.: 40°C; Detection: ESI-MS/MS (+)  
Inj. vol.: 0.5  $\mu\text{L}$  (0.1 mg/L)  
Sample: 1. Famotidine; 2. Ranitidine; 3. Cimetidine

## Metal-free column

The performance of packing materials is most important in the evaluation of metal-free column. Since the packing materials for the *L-column* series suppress the influence of metal impurities, the peak of the compounds that are easily subjected to metal coordination can be sharply detected. Furthermore, since the *L-column3* metal-free column can be used in a wide range of pH values, an improvement in sensitivity and separation behavior can be expected.

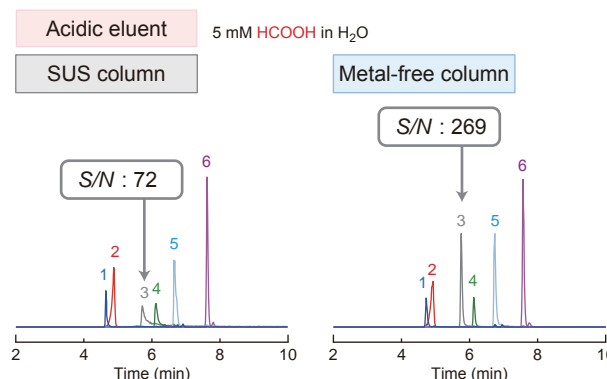
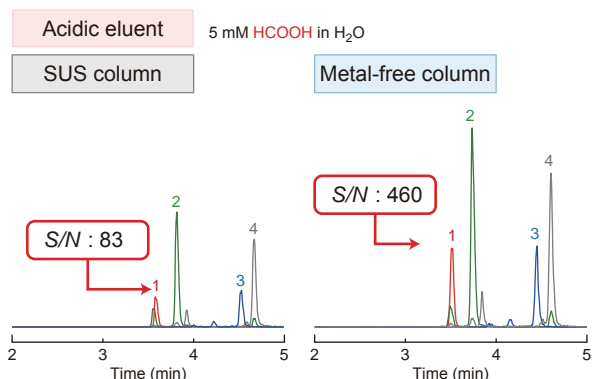

### Antibiotics (tetracycline)

[Analytical conditions]  
 Column: *L-column3* C18, 3 μm; Size: 2.0 mm or 2.1 mm I.D., 50 mm L.  
 Eluent: A: CH<sub>3</sub>CN, B: 5 mM HCOOH in H<sub>2</sub>O  
 A/B, 1/99-60/40 (0-5 min)  
 Flow rate: 0.2 mL/min; Temp.: 15°C; Detection: ESI-MS/MS (+)  
 Inj. vol.: 1 μL (50 μg/L)  
 Sample: 1. Oxytetracycline (OTC); 2. Tetracycline (TC)  
 3. Chlortetracycline (CTC); 4. Doxycycline (DC)

- S/N : Signal to noise ratio

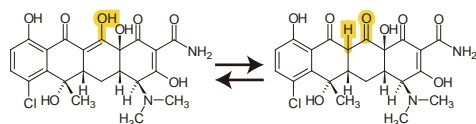

Keto-enol tautomerism of CTC

As the antibiotics of tetracycline base coordinates\* with the metal ions at the β-diketone location in the structure, they are strongly influenced by the metal.

The tetracycline has keto-enol tautomerism, and the peak leading of CTC and DC occurs. This change can be suppressed by setting the column temperature low.

\* Quoted from Standard Methods of Analysis in Food Safety Regulation, Animal Drugs and Feed Additives, Part 2003

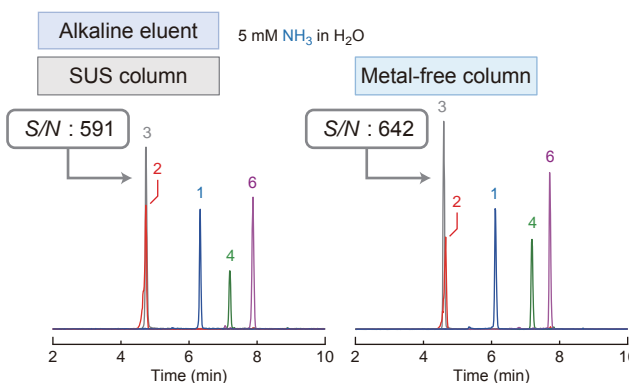

### Modified peptides

[Analytical conditions]  
 Column: *L-column3* C18, 3 μm; Size: 2.0 mm or 2.1 mm I.D., 50 mm L.  
 Eluent: A: CH<sub>3</sub>CN, B: Aqueous solution  
 A/B, 2/98-40/60 (0-10 min)  
 Flow rate: 0.2 mL/min; Temp.: 40°C; Detection: ESI-MS/MS (+)  
 Inj. vol.: 1 μL (1 pmol/μL 0.1% HCOOH in H<sub>2</sub>O)  
 Sample: 1. Oxidized ACTH (1-10) Oxide peptide  
 2. Glycosylated EPO (117-131) Glycosylated peptide  
 3. Phosphorylated Angiotensin II Phosphorylated peptide  
 4. Nitrated Angiotensin I Nitrated peptide  
 5. Methylated Substance P Methylated peptide  
 6. Acetylated Calcitonin (15-29) Acetylated peptide

- S/N : Signal to noise ratio

### <Precautions for use>

- In order to sufficiently achieve the potential performance of a metal-free column, change the materials of tubings and needles to non-metal materials for use in a metal-free system environment.
- Solvent that degrades PEEK cannot be used.
- The metal-free column has withstand pressure equivalent to that of general-purpose stainless-steel columns. Determine the column pressure in reference to the following maximum pressure as a guideline.

Column Length	Particle size:	5 μm	3 μm	2 μm
50 mm		10 MPa	20 MPa	40 MPa
100 mm		15 MPa	25 MPa	60 MPa
150 mm		15 MPa	25 MPa	80 MPa
250 mm		20 MPa	30 MPa	-

The hardware made of a PEEK lined stainless-steel tube installed with PEEK frits is designed so that it can be used up to pH 12.

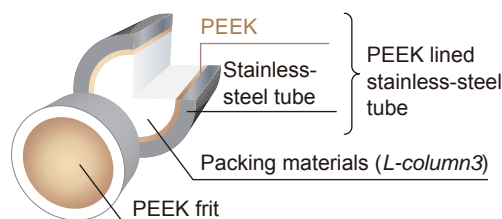

## Technical report

### ■ Degradation mechanism of silica-based columns by alkaline solution

Packing materials using silica as the base material have many types of bonded phases and particle sizes. The columns packed with them are general purpose. However, in an alkaline solution, hydroxide ion dissolves silica (Step 1). Furthermore, the vacant space produced by the dissolution of silica at the top of the column significantly deteriorates the performance of the column (Step 2). Therefore, the pH range of an eluent is limited.

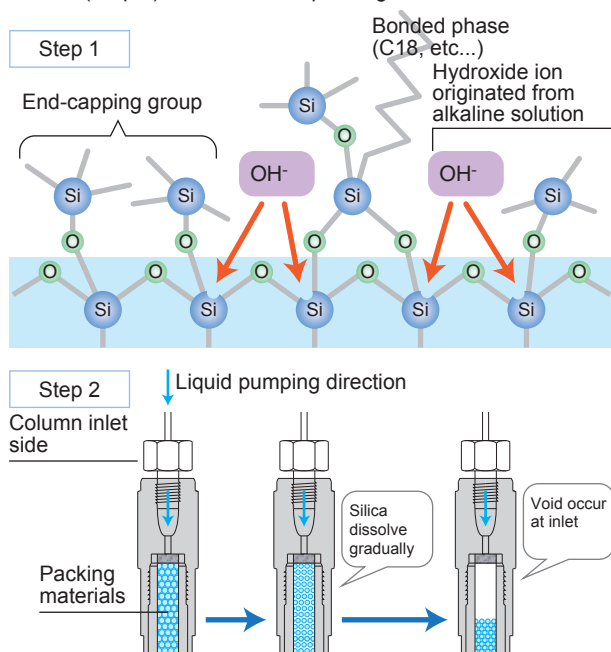

Fig. 1 Image of silica dissolved by alkaline solution

### ■ Alkaline resistance of L-column3

Recently, many manufacturers sell columns usable for an alkaline eluent. While *L-column2* is usable for pH 1 to pH 9, *L-column3* became usable for pH 1 to pH 12 (Fig. 2). The columns with durability in a wide range of pH values are very advantageous in the development of methods of analysis and from the economic viewpoint. The high durability is an important factor in the selection of columns.

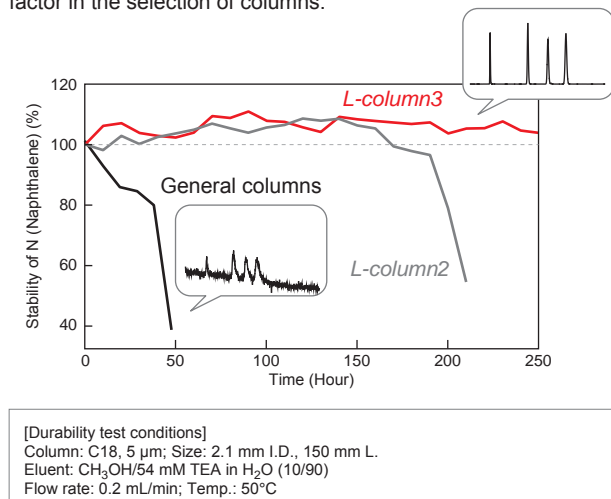
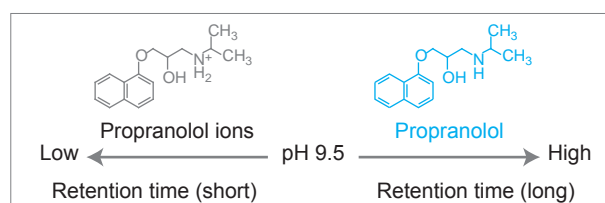

Fig. 2 Durability test of alkaline eluent (pH 12)

### ■ Advantage of using alkaline eluent

#### “Capable of analysis when dissociation is suppressed”

An ionic compound has the same concentration under dissociation and non-dissociation conditions when pH is the same as pKa. In propranolol as a basic drug, many propranolol ions exist at a pH lower than 9.5, and many propranolol molecules exist at a pH higher than 9.5. The retention by propranolol ions is weak, and the retention by propranolol molecules is strong.



Since general C18 silics-based columns can only analyze by propranolol ions, retention should be enhanced by adding an ion-pair reagent (Fig. 3 (1)).

Because *L-column3* with a wide range of pH values use can analyze basic compounds under the condition of suppressed dissociation, sufficient retention can be obtained in a simple eluent composition (Fig. 3 (2)).

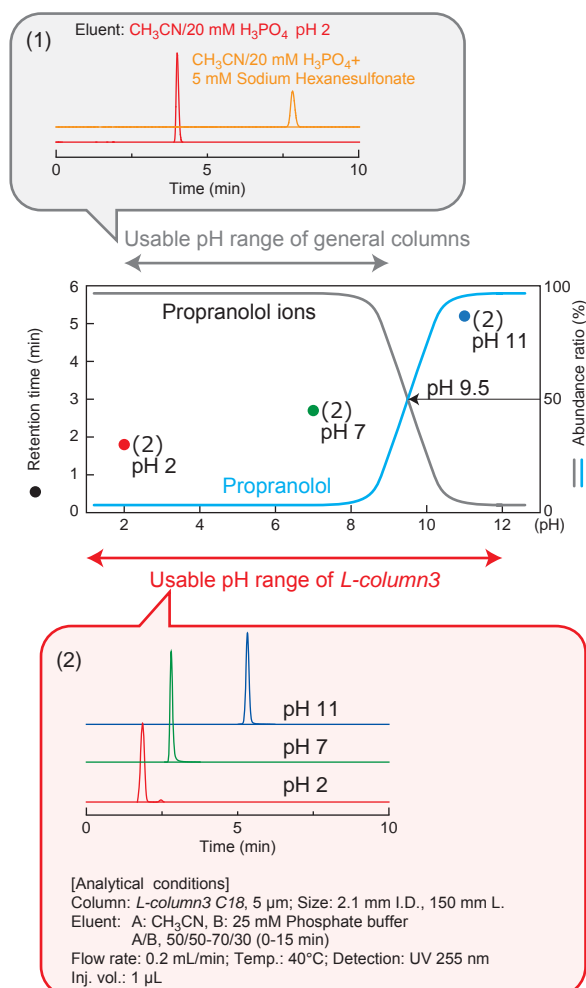

Fig. 3 Abundance ratio and retention time due to pH change (propranolol)

## Technical report

### “Changing separation behavior of ionic compounds by simultaneous multicomponent analysis”

Changing the pH of an eluent changes the retention behavior of the ionic compounds.

Because *L-column3* is usable within the range of pH 1 to pH 12, the pH of the eluent can be changed significantly.

Changing the pH enables an improvement in separation.

### “Improvement of peak intensity”

In the LC/MS often used for trace analysis, peak intensity is important. In the analysis of a basic compounds, higher pH values of an eluent enable the acquisition of sufficient retention and peak intensity. This is an advantage in the use of an alkaline eluent.

Fig. 4 shows the peak area ratio assuming the peak area to be “1” when formic acid is used as an eluent. The peak area of ibuprofen, an acidic drug, changes little even if the pH of the eluent changes. On the other hand, an increase in the pH of the eluent increases the peak area of amitriptyline.

The selection of the pH value of the eluent matching the purpose of the analysis is recommended.

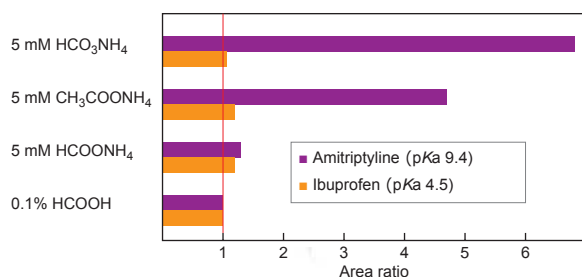

[Analytical conditions]  
Column: *L-column2* ODS, 3  $\mu$ m; Size: 2.1 mm I.D., 50 mm L.  
Eluent: A: CH<sub>3</sub>CN, B: Aqueous solution, A/B, Gradient elution  
Temp.: 40°C; Inj. vol.: 5  $\mu$ L

Fig. 4 Comparison of peak area ratio

### ■ Precautions when using an alkaline eluent

Even when using some chemically stable columns, using the eluent with high pH is very severe conditions for the column. The selection of an eluent with the pH matching the purpose of the analysis is recommended. Strictly follow the operation manual for columns when using an eluent with allowable pH. Even allowable pH promotes deterioration of the performance of the column in the following cases:

- Ratio of organic solvent is low.
- High column temperature.
- Eluent is added in a high concentration.

Parts of the LC or LC/MS to be used may be replaced with those resistant to alkaline. Ask the manufacturer for further information. After use, wash the column and the flow channel with an eluent not containing additives.

#### <Supplement>

The method for preparing an eluent in this catalog is as follows:

Select the grade of reagent (for HPLC) based on the purpose of the analysis. Chemical change, pH change, and rotting by the microorganism may occur after the preparation. Completely use the eluent within one or two days.

- 0.1% formic acid solution  
Formic acid 1 mL  
Add water to prepare a total volume of 1000 mL
- 5 mM ammonium formate solution  
1 mol/L ammonium formate solution 5 mL  
Add water to prepare a total volume of 1000 mL
- 5 mM ammonium acetate solution  
1 mol/L ammonium acetate solution 5 mL  
Add water to prepare a total volume of 1000 mL
- 5 mM ammonium hydrogen carbonate ( ammonium bicarbonate) solution  
Ammonium hydrogen carbonate (M.W = 79.06) 0.40 g  
Add water to prepare a total volume of 1000 mL
- 5 mM ammonium (ammonium hydroxide) solution  
28% ammonia water 334  $\mu$ L  
Add water to prepare a total volume of 1000 mL
- 25 mM Phosphate buffer pH 2  
Phosphoric acid (85%) 1020  $\mu$ L (equivalent to 15 mM)  
Sodium dihydrogen phosphate dihydrate 1.56 g (equivalent to 10 mM)  
Add water to prepare a total volume of 1000 mL
- 25 mM Phosphate buffer pH 7  
Potassium dihydrogen phosphate 1.36 g (equivalent to 10 mM)  
Disodium hydrogen phosphate nonahydrate 2.13 g (equivalent to 15 mM)  
Add water to prepare a total volume of 1000 mL
- 25 mM Phosphate buffer pH 11  
Dipotassium hydrogen phosphate 4.17 g (equivalent to 24 mM)  
Tripotassium phosphate 0.23 g (equivalent to 1 mM)  
Add water to prepare a total volume of 1000 mL



## Line up

Packing materials: *L-column3 C18* (USP category: L 1) (Octadecylsilanized silica gel for liquid chromatography)

Particle size	Inner diameter	Cat.No.	Length							
			10 mm	20 mm	30 mm	50 mm	75 mm	100 mm	150 mm	250 mm
2 $\mu$ m	1.0 mm	Cat.No.				813740		813610	813190	
		Price (JPY)								
	2.1 mm	Cat.No.	813780	813770	813630	813140	813640	813170	813020	
		Price (JPY)								
	3.0 mm	Cat.No.			823650	823490	823600	823330		
		Price (JPY)								
3 $\mu$ m	1.0 mm	Cat.No.				811740		811610	811190	
		Price (JPY)								
	1.5 mm	Cat.No.				811130		811160	811010	
	2.1 mm	Cat.No.	811780	811770	811630	811140	811640	811170	811020	811220
	3.0 mm	Cat.No.			821650	821490	821600	821330	821260	821320
		Price (JPY)								
	4.6 mm	Cat.No.			821060	821150	821460	821180	821070	821080
		Price (JPY)								
5 $\mu$ m	1.0 mm	Cat.No.				812740		812610		
		Price (JPY)								
	1.5 mm	Cat.No.				812130		812160	812010	
	2.1 mm	Cat.No.			812630	812140		812170	812020	812220
	3.0 mm	Cat.No.						822330	822260	822320
		Price (JPY)								
	4.0 mm	Cat.No.							822040	822310
4.6 mm	Cat.No.			822060	822150		822180	822070	822080	
	Price (JPY)									
	10.0 mm	Cat.No.							842510	842100
		Price (JPY)								

- Connection type: 1/16" Waters.

Packing materials: *L-column3 C8* (USP category: L 7) (Octylsilanized silica gel for liquid chromatography)

Particle size	Inner diameter	Cat.No.	Length							
			10 mm	20 mm	30 mm	50 mm	75 mm	100 mm	150 mm	250 mm
3 $\mu$ m	1.5 mm	Cat.No.				811131		811161	811011	
	2.1 mm	Cat.No.	811781	811771	811631	811141	811641	811171	811021	811221
	3.0 mm	Cat.No.			821651	821491	821601	821331	821261	821321
		Price (JPY)								
	4.6 mm	Cat.No.			821061	821151	821461	821181	821071	821081
		Price (JPY)								
5 $\mu$ m	1.5 mm	Cat.No.				812131		812161	812011	
	2.1 mm	Cat.No.			812631	812141		812171	812021	812221
	3.0 mm	Cat.No.						822331	822261	822321
		Price (JPY)								
	4.0 mm	Cat.No.							822041	822311
4.6 mm	Cat.No.			822061	822151		822181	822071	822081	
		Price (JPY)								

- Connection type: 1/16" Waters.

## Line up

### Guard column (cartridge type)

Packing materials	Particle size	Inner diameter	Length	Specification	Cat.No.	Price (JPY)
<i>L-column3 C18</i>	5 $\mu$ m	2.0 mm	5 mm	Cartridge (3 pcs)	852330	
		4.6 mm	10 mm	Cartridge (3 pcs)	852050	
<i>L-column3 C8</i>	5 $\mu$ m	2.0 mm	5 mm	Cartridge (3 pcs)	852331	
		4.6 mm	10 mm	Cartridge (3 pcs)	852051	
Holder	Direct type	For 2.0 mm I.D.		(1 pc)	651332	
		For 4.6 mm I.D.		(1 pc)	651052	
	Non-direct type	For 2.0 mm I.D.		(1 pc)	652332	
		For 4.6 mm I.D.		(1 pc)	652052	

- Connection type: 1/16" Waters.

- Select a guard column with the same inner diameter as that of the analytical column or a smaller inner diameter than that of the analytical column.

- The direct connection type of dedicated holder can be directly connected to the analytical column. The indirect connection type requires tubing and connectors to connect the holder and the analytical column.

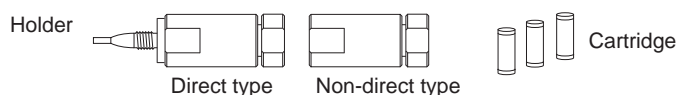

### Metal-free column

Packing materials	Particle size	Inner diameter	Cat.No.	Length			
				50 mm	100 mm	150 mm	250 mm
<i>L-column3 C18</i>	2 $\mu$ m	2.0 mm	Cat.No.	863140	863170	863020	
			Price (JPY)				
	3 $\mu$ m	2.0 mm	Cat.No.	861140	861170	861020	861220
			Price (JPY)				
	5 $\mu$ m	2.0 mm	Cat.No.	862140	862170	862020	862220
			Price (JPY)				
<i>L-column3 C8</i>	3 $\mu$ m	2.0 mm	Cat.No.	861141	861171	861021	861221
			Price (JPY)				
	5 $\mu$ m	2.0 mm	Cat.No.	862141	862171	862021	862221
			Price (JPY)				

- Connection type: 1/16" Waters.

### Pre-column filter

Specification		Cat.No.	Price (JPY)
Filter (1 pc), holder W+W (1 pc)	Connection type: Column side, Waters type; LC tubing side, Waters type	653002	
Filter (1 pc), holder W+U (1 pc)	Connection type: Column side, Waters type; LC tubing side, UPLC® type	653004	
Filter (5 pcs)	For replacement	653003	

- The precolumn filter prevents the entry of insoluble compounds and protects the analytical column..

### ■ About connection type (joint)

The connection type (joint and thread type) of column is divided into several types. The connection type is distinguished by different tubing lengths at the end of the ferule.

Always connect by using the same connection type for the LC tubing and the column or by using tough connectors and Pre-column filter to avoid the generation of dead volume.

The connection of *L-column3* is the Waters type (unified fine thread No.10-32UNF, outer diameter of tubing 1/16").

Column end-fitting (W)

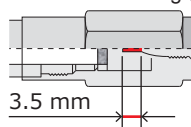

Tube fitting (Waters type, W)

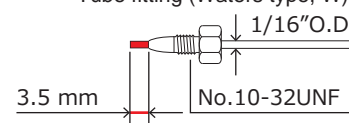

Tube fitting (UPLC® type, U)

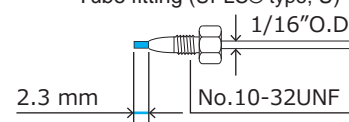

- Length figures: actual measurement value

## Reference: About L-column series

The L-column series appeared in 1990 and evolved corresponding to user needs with the concept of low adsorption, high durability, high resolution, and high reproducibility. We earned a very favorable reputation because of our untiring efforts for performance and quality and a consistent stable supply for many years.

Packing materials	USP category	Particle Size (μm)	Pore Size (nm)	Micro column	Semi-micro and general-purpose column	Semi preparation column	Metal-free column	
				Inner diameter less than 1 mm	Inner diameter 1 mm or more and less than 10 mm	Inner diameter 10 mm or more		
L-column	L-column ODS	L 1	3, 5	12	○	○	○	-
	L-column ODS-P	L 1	5	30	○	○	-	-
	L-column C8	L 7	5	12	○	○	-	-
L-column2	L-column2 ODS	L 1	2, 3, 5	12	○	○	○	○
	L-column2 C8	L 7	3, 5	12	○	○	-	○
	L-column2 C6-Phenyl	L 11	3, 5	12	○	○	-	○
L-column3	L-column3 C18	L 1	2, 3, 5	12	-	○	○	○
	L-column3 C8	L 7	3, 5	12	-	○	-	○

Classification by inner diameter cited from JIS K 0124:2011

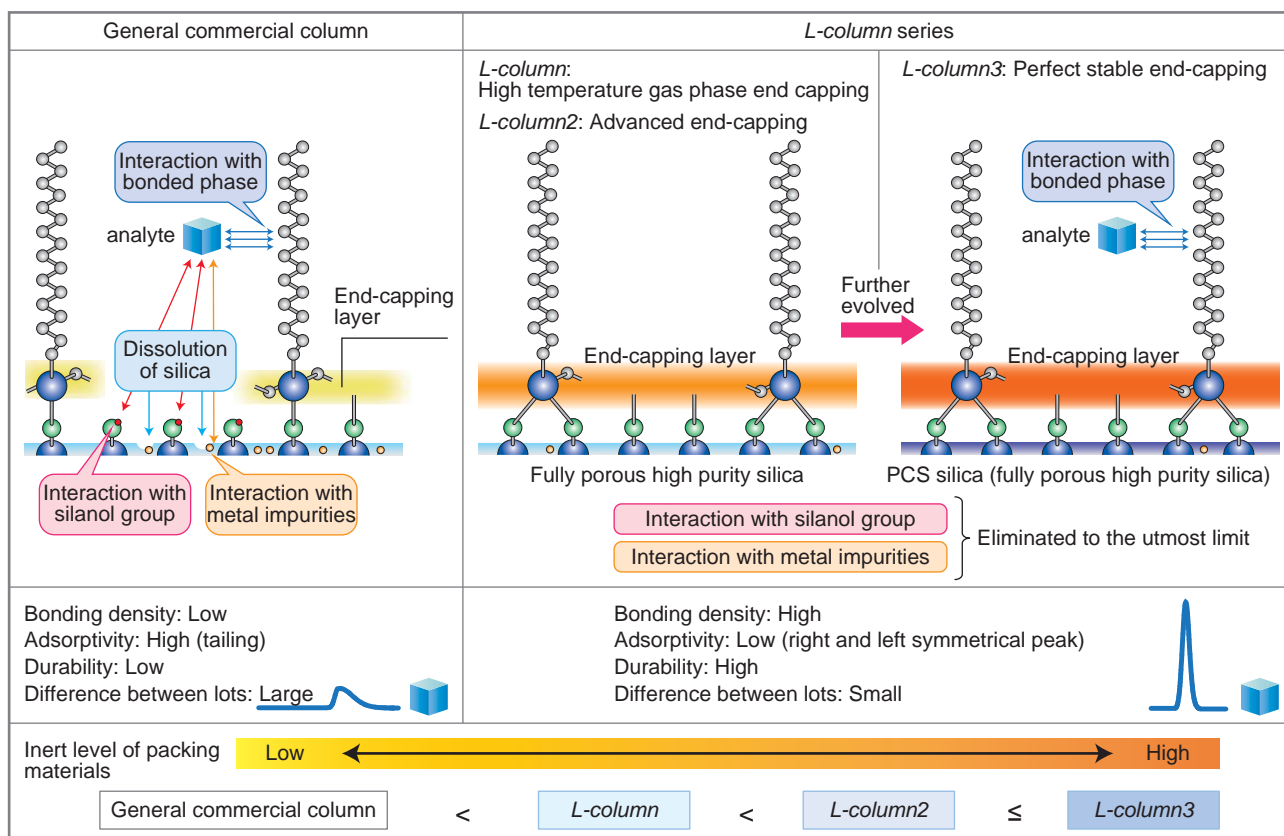

The silica-based reversed phase columns are created by modifying the bonded phases on the surface of the silica and end-capping silanol groups. Although end-capping is performed using different methods depending on manufacturers, the complete elimination of the silanol groups is difficult. Therefore, the peak of the analyte is subjected to tailing because of the interaction with the silanol groups or metal impurities.

The L-column series eliminated the secondary interaction (interaction with silanol groups and metal impurities) of the silica base reversed phase column to the utmost limit by applying unique end-capping technology and pursued the separation mechanism of an original column. Since the L-column ODS entered the stage in 1990, the columns have continually evolved.



## Reference: About L-column series

The L-column series may present a different separation pattern in a simultaneous multicomponent analysis even when using the same C18 (ODS) column because the manufacturing method for the packing materials is different.

	L-column	L-column2	L-column3
Base material	Fully porous high purity silica	Fully porous high purity silica	PCS silica (Fully porous high purity silica)
End-capping	High temperature gas phase end-capping	Advanced end-capping	Perfect stable end-capping
Usable pH range *	pH 2 - pH 9	pH 1 - pH 9	pH 1 - pH 12
Features	You can use without worry because this has been stably supplied since 1990.	The influence of the silanol group was eliminated to the utmost limit. It offers an abundant lineup, such as the phenyl column, micro column, and nano column with inner diameters less than 1 mm. Metal free columns (glass lining) are also available.	When comparing the L-column and the L-column2, retention is weaker, and stereoselectivity is a little lower. The inert level of packing material is high, and it has low adsorptivity equivalent to that of the L-column2. Not only the alkaline resistance but also the durability in an eluent with high water ratio were dramatically improved. Metal free columns (PEEK lining) are also available.
Characteristic test	Cat.No.622070 Column: C18, 5 μm Size: 4.6 mm I.D., 150 mm L.	Cat.No.722070	Cat.No.822070
1. Uracil 2. Caffeine 3. Phenol 4. Butylbenzene 5. o-Terphenyl 6. Amylbenzene 7. Triphenylene	<p>Hydrogen bond property : 0.52 Hydrophobicity : 1.47 Stereoselectivity : 1.55</p>	<p>Hydrogen bond property : 0.46 Hydrophobicity : 1.46 Stereoselectivity : 1.58</p>	<p>Hydrogen bond property : 0.46 Hydrophobicity : 1.45 Stereoselectivity : 1.35</p>
Adsorptivity (SSRI)	Cat.No.622070 Column: C18, 5 μm Size: 4.6 mm I.D., 150 mm L.	Cat.No.722070	Cat.No.822070
1. Paroxetine 2. Citalopram 3. Fluoxetine	<p><math>S_{(3)} : 1.58</math></p>	<p><math>S_{(3)} : 1.38</math></p>	<p><math>S_{(3)} : 1.24</math></p>

\* In case the bonded phase is C18 (ODS)

The characteristic test evaluates the following values:

<Hydrogen bond property>  $k(\text{Caffeine}) / k(\text{Phenol})$

This is the value representing the influence of the hydrogen bond of the silanol group of packing materials and the samples as represented by the ratio of the retention factors of caffeine with high hydrogen bond property and phenol with low hydrogen bond property. The larger the value of "hydrogen bond property", the hydrogen bonds are easy to occur between analyte and packing materials.

<Hydrophobicity>  $k(\text{Amylbenzene}) / k(\text{Butylbenzene})$

This is the value representing the magnitude of the retention force of packing materials as represented by the ratio of the retention factors of amyl benzene and butyl benzene. The larger the value of hydrophobicity, the higher the hydrophobicity of the packing materials and the longer the retention time.

<Stereoselectivity>  $k(\text{Triphenylene}) / k(\text{o-Terphenyl})$

This is the value representing the plane recognition ability as represented by the ratio of the retention factors of triphenylene with a plane structure and o-terphenyl with a three-dimensional structure. The larger the value of stereoselectivity, the stronger the retention of a compound with a plane structure.

- k: Retention factor, S: Symmetry factor

Reference: Line up *L-column*, *L-column2**L-column2*

Packing materials	Particle size	Inner diameter	Length						
			30 mm	50 mm	75 mm	100 mm	150 mm	250 mm	
<i>L-column2</i> ODS (USP category: L 1)	2 $\mu$ m	2.1 mm	Cat.No.	713630	713140	713640	713170	713020	
			Price (JPY)						
		3.0 mm	Cat.No.	723650	723490	723600	723330		
			Price (JPY)						
	3 $\mu$ m	2.1 mm	Cat.No.	711630	711140	711640	711170	711020	711220
		3.0 mm	Cat.No.	721650	721490	721600	721330	721260	721320
			Price (JPY)						
		4.6 mm	Cat.No.		721150	721460	721180	721070	721080
			Price (JPY)						
	5 $\mu$ m	1.5 mm	Cat.No.		712130		712160	712010	
		2.1 mm	Cat.No.		712140		712170	712020	712220
			Price (JPY)						
	4.6 mm	Cat.No.		722150		722180	722070	722080	
		Price (JPY)							
<i>L-column2</i> C8 (USP category: L 7)	3 $\mu$ m	2.1 mm	Cat.No.	711631	711141	711641	711171	711021	711221
		3.0 mm	Cat.No.	721651	721491	721601	721331	721261	721321
			Price (JPY)						
		4.6 mm	Cat.No.		721151	721461	721181	721071	721081
			Price (JPY)						
	5 $\mu$ m	2.1 mm	Cat.No.		712141		712171	712021	712221
		Price (JPY)							
4.6 mm		Cat.No.		722151		722181	722071	722081	
		Price (JPY)							
<i>L-column2</i> C6-Phenyl (USP category: L 11)	3 $\mu$ m	2.1 mm	Cat.No.	711636	711146	711646	711176	711026	711226
		3.0 mm	Cat.No.	721656	721496	721606	721336	721266	721326
			Price (JPY)						
		4.6 mm	Cat.No.		721156	721466	721186	721076	721086
			Price (JPY)						
	5 $\mu$ m	2.1 mm	Cat.No.		712146		712176	712026	712226
		Price (JPY)							
4.6 mm		Cat.No.		722156		722186	722076	722086	
		Price (JPY)							

- Connection type: 1/16" Waters.

*L-column2* Metal-free column

Packing materials	Particle size	Inner diameter	Length				
			50 mm	100 mm	150 mm	250 mm	
<i>L-column2</i> ODS (USP category: L 1)	3 $\mu$ m	2.0 mm	Cat.No.	731140	731170	731020	731220
			Price (JPY)				
	5 $\mu$ m	2.0 mm	Cat.No.	732140	732170	732020	732220
		Price (JPY)					

- *L-column2* Metal-free column is made from the combination of a glass lined stainless steel tube and polymer frits.  
- Connection type: 1/16" Waters.

## Reference: Line up L-column, L-column2

## L-column

Packing materials	Particle size	Inner diameter	Length							
			30 mm	50 mm	75 mm	100 mm	150 mm	250 mm		
L-column ODS (USP category: L 1)	3 µm	2.1 mm	Cat.No.	611630	611140	611640	611170	611020	611220	
		3.0 mm	Cat.No.	621650	621490	621600	621330	621260	621320	
		Price (JPY)								
	5 µm	4.6 mm	Cat.No.		621150	621460	621180	621070	621080	
		Price (JPY)								
		2.1 mm	Cat.No.		612140		612170	612020	612220	
Price (JPY)										
L-column ODS-P (USP category: L 1)	5 µm	4.6 mm	Cat.No.		622150		622180	622070	622080	
		Price (JPY)								
		2.1 mm	Cat.No.		612147		612177	612027	612227	
Price (JPY)										
L-column C8 (USP category: L 7)	5 µm	4.6 mm	Cat.No.		622157		622187	622077	622087	
		Price (JPY)								
		2.1 mm	Cat.No.		612141		612171	612021	612221	
Price (JPY)										

- Connection type: 1/16" Waters.

## Nano column / micro column with 0.075 mm I.D. - 0.3 mm I.D.

Packing materials	Inner diameter	Length							
		Particle size: 2 µm		Particle size: 3 µm		Particle size: 5 µm			
		50 mm	150 mm	50 mm	150 mm	500 mm	50 mm	150 mm	
L-column2 ODS (USP category: L 1)	0.075 mm	Cat.No.			711410	711420	711800	712410	712420
	0.1 mm	Cat.No.			711390	711400	711810	712390	712400
	0.2 mm	Cat.No.	713290	713300	711290	711300		712290	712300
	0.3 mm	Cat.No.	713270	713280	711270	711280		712270	712280
	Price (JPY)								
L-column ODS (USP category: L 1)	0.075 mm	Cat.No.			611410	611420		612410	612420
	0.1 mm	Cat.No.			611390	611400		612390	612400
	0.2 mm	Cat.No.			611290	611300		612290	612300
	0.3 mm	Cat.No.			611270	611280		612270	612280
	Price (JPY)								

- Connection type: Valco

## Trap column (cartridge type)

Packing materials	Particle size	Inner diameter	Length	Specification	Cat.No.	Price (JPY)
L-column2 ODS	5 µm	0.3 mm	5 mm	Cartridge (3 pcs)	752450	
L-column ODS	5 µm	0.3 mm	5 mm	Cartridge (3 pcs)	652450	
Holder		For 0.3 mm I.D.		(1 pc)	652452	

- Connection type: 1/16" Waters.

Holder



Cartridge



LC column catalog  
L-column3  
Ver. 02

# Chemicals Evaluation and Research Institute, Japan

- The product specifications are as of January 1, 2023. Please note that they may be changed without prior notice.
- For questions about part prices or ordering, please contact the Chromatography Department of CERI or a nearby agency. Details are provided on the page for the Chromatography Department of our website. Please use them as a reference.

**CERI**

一般財団法人 化学物質評価研究機構  
Chemicals Evaluation and Research Institute, Japan

<https://www.cerij.or.jp>

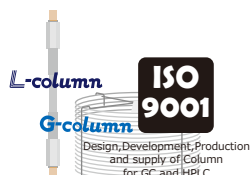

**CERI Tokyo  
Chromatography department**

e-mail [chromato@ceri.jp](mailto:chromato@ceri.jp)

FAX +81-480-37-2521

1600 Shimotakano, Sugito-machi, Kitakatsushika-gun,  
Saitama 345-0043, Japan