



OPTIMIZE TECHNOLOGIES

CHROMATOGRAPHY FOR THE WORLD SINCE 1985

13993 Fir Street
Oregon City, OR 97045
TF: 800-669-9015
Tel: 503-557-9994
Fax: 503-557-9995
www.optimize-tech.com

OPTIMIZE TECHNOLOGIES



We are continually developing new products to meet the needs of our customers.

For the complete Optimize product line including items not featured in this publication, please contact us directly or visit www.optimize-tech.com.

We look forward to helping you.

Cover Image:

Candyland (2007) : Painted Hills, Oregon :
Photography by Marc Adamus.
www.marcadamus.com



OPTIMIZE TECHNOLOGIES

is dedicated to providing the highest quality HPLC, UHPLC and LC/MS products available. We combine innovative design and superior performance to create products that are straight forward, yet elegant, solutions to daily issues in the lab.

For example, the EXP product family provides reusable hand-tight connections and cartridge replacement for UHPLC pressures of 20,000+ psi. The OPTI-LYNX system provides low-dispersion quick-connect capabilities for many applications rated to 6,000 psi. Our piston seals employ unique polymer blends to provide the ultimate performance. Check valve ball and seat sets are perfectly mated and feature optimized geometry for the fastest response time and flawless operation.

SERVICE

We are constantly developing new products and expanding existing offerings. Please contact us if you have a custom designs requirement or need support with your scientific instrumentation. Optimize welcomes the opportunity to provide custom designs and engineering solutions.

We promise to bring you innovative products that offer unmatched performance, quality, and ease of use - all backed with the most responsive and effective customer service in the industry.

Thank you for your business.

OUR BRANDS

EXP®
UHPLC Fittings,
Filters, Traps, Guards
and Analytical Columns



OPTI-LYNX™
Quick-Connect
Filters, Traps & Guards



OPTI-LOK™
Fittings



OPTI-PEEK™
Tubing



OPTI-SOLV®
Filtration



OPTI-TRAP™
Trap Columns



OPTI-GUARD®
Guard Columns



OPTI-MAX®
Check Valves



OPTI-SEAL®
UHMW-PE Seals



ITB™
PTFE Seals



UHP



ULTRA HIGH PRESSURE

20,000+psi / 1,400+bar

HP



HIGH PRESSURE

6,000psi / 400bar

MP



MEDIUM PRESSURE

1,500psi / 100bar

LP



LOW PRESSURE

>1000psi / >70bar



OPTIMIZE
TECHNOLOGIES

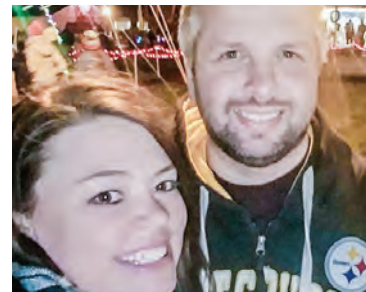

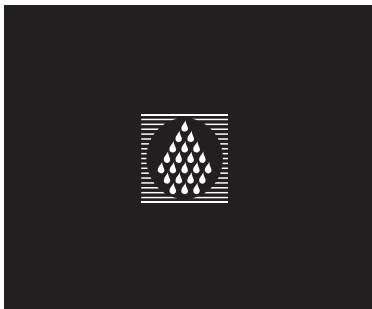

We are Optimize Technologies

At Optimize, customer service isn't just a department—it's who we are. We are sales and quality assurance professionals, technical support specialists, machinists, engineers and chemists. We are here to support customers every step of the way. Optimize is committed to delivering innovative products that provide optimal performance.



Innovative **HPLC**,
UHPLC and **LC/MS**
products proudly
designed and
manufactured in
Oregon since 1985



Multnomah Falls, Oregon

OPTIMIZE PROFILE

- 1 | **Optimize** Manufacturing
- 2 | **Optimize** Custom Products
- 3-4 | Innovation Spotlight: **EXP**[®]
- 5-6 | Innovation Spotlight: **OPTI-LYNX**[™]

FITTINGS, ADAPTERS & TUBING

- 7-8 | Introduction
- 9 | **OPTI-LOK**[™] Low Pressure Fittings
- 10 | **OPTI-LOK**[™] High Pressure Fittings
- 11 | OEM Specific Fittings
- 12 | **OPTI-LOK**[™] Adapters
- 13-14 | **EXP**[®] & **EXP**^{®2} UHPLC Fittings
- 15-18 | **EXP**^{®2} TI-LOK[™] Fittings
- 19-20 | Tubing and Tubing Cutters

FILTRATION

- 21-22 | Introduction
- 23 | **OPTI-SOLV**[®] Solvent Reservoir Filters
- 24 | **OPTI-SOLV**[®] In-Line Filter
- 25 | **OPTI-SOLV**[®] Mini Filter
- 26 | **OPTI-SOLV**[®] Micro and Nano Filters
- 27 | **EXP**[®] Stem Filter
- 28 | **EXP**^{®2} In-Line Pre-Column

TRAP COLUMNS

29-30	Introduction
31	OPTI- TRAP [™] Trap Column
32	OPTI- LYNX [™] Micro Trap
33-34	EXP [®] 2 Nano Trap
35-36	EXP [®] Stem Trap
37-38	EXP [®] Trap Column

GUARD COLUMNS

39-40	Introduction
41	OPTI- GUARD [®] 1mm Guard Column
42	EXP [®] Guard Column

ANALYTICAL COLUMNS

43	EXP [®] Analytical Column
----	---

BACK PRESSURE REGULATORS

44

OEM REPLACEMENT PARTS

45-73

LC TRAPPING

75-76	Introduction
77-78	Sample Pre-Concentration
79-80	Detergent Removal
81-87	Trap Specifics
81	Small Molecule
82	Peptide
83	Protein
84	SDS
85	NID
86	SCX
87	ISRP

RESOURCES

88	Patents & Trademarks
89-90	Index
91	Ordering

OPTIMIZE MANUFACTURING PRECISION MACHINING

Optimize products are manufactured by skilled machinists at our facility in Oregon City, Oregon. To meet exacting standards for quality and reliability, designs push the limits of manufacturing tolerances. To achieve these dimensional tolerance controls, we individually machine components and avoid mold-based manufacturing techniques. We ensure the consistency of our manufacturing process with a rigorous quality control program.

THE DRIVING FORCE

Innovation started Optimize and innovation continues to fuel our progress. The Auto-Adjusting Stem, Hand-Tight EXP hardware rated to 20,000 psi, OPTI-MAX check valve components and the OPTI-LYNX quick-connect system exemplify our commitment to the highest quality products. We push the limits of excellence in everything we create.

RESEARCH & DEVELOPMENT

At Optimize, we are committed to research and development. Our team of engineers and chemists are constantly engaging in the evaluation of existing product designs and the conceptualization of new products. Our collaborative efforts with original equipment manufacturers (OEMs) and pharmaceutical research companies have resulted in customized components and devices for unique applications.

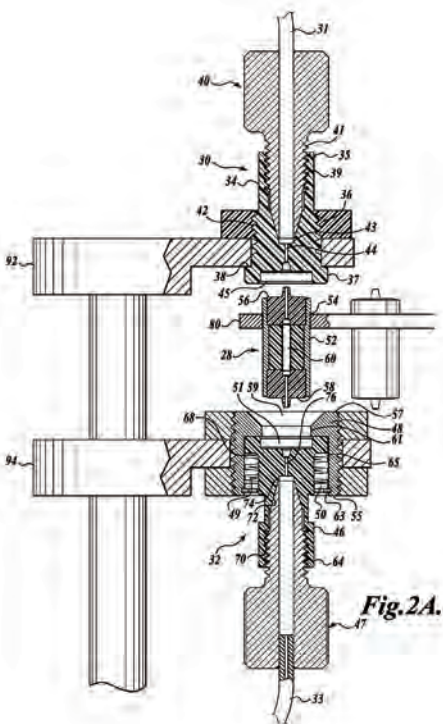
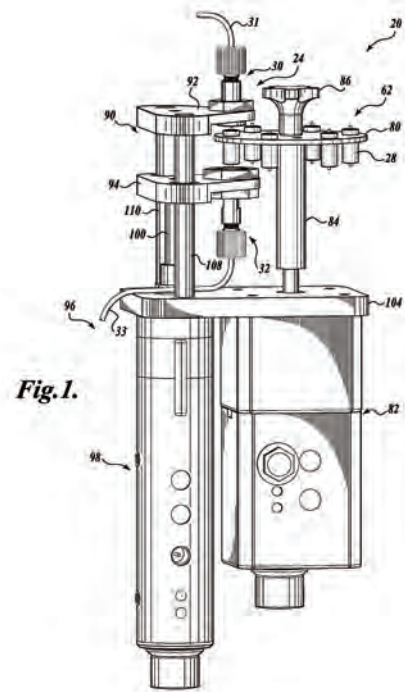

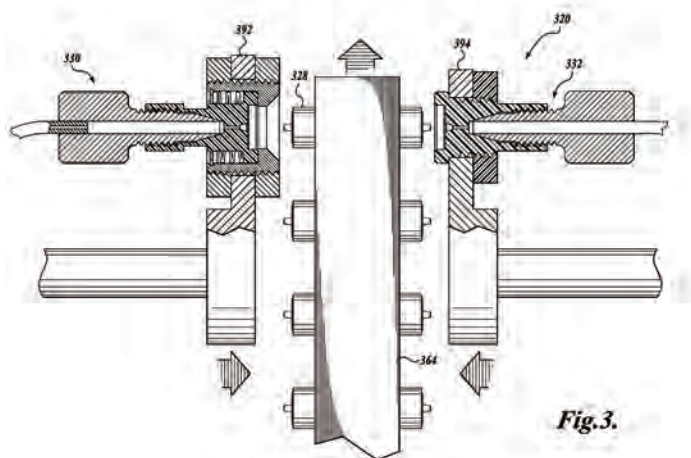

Some of the industries we serve

- Chromatography
- Drug Discovery
- Mass Spectrometry
- Nuclear Pharmacy
- Clinical
- Environmental
- Petrochemical
- Biodefense
- Pharmaceuticals

CUSTOM DESIGN & MANUFACTURING

SPECIFIC NEEDS, SPECIFIC RESULTS

Team with Optimize Technologies to bring your ideas to reality. From simple one-piece fittings to entire fluid handling assemblies – no project is too small or too large. Optimize specializes in custom design and development services including packed-bed products, quick-connect technology and complex fluid handling devices. Offering patented features such as EXP, OPTI-LYNX and OPTI-SOLV, we are able to customize existing products and design new solutions to meet your specifications.

Virtually all products are manufactured and designed in Oregon, USA. On-site engineering and manufacturing allows us to make rapid changes during the production process to meet the needs of our customers. Highly experienced machinists bring to life the innovations created by a team of design specialists, engineers and chemists. Our quality assurance professionals have a reputation for being the most demanding in the field, ensuring all Optimize products meet or exceed the highest standards in the industry.

OPTIMIZE PARTNERS

SEE WHAT OUR CUSTOMERS ARE SAYING

Our partnerships continue to benefit a variety of companies and customers with diverse applications. Optimize is the perfect partner to adapt existing designs to specific applications, to engineer solutions for problematic situations and create innovative products. To see what our customers are saying, please visit our website, www.optimize-tech.com/testimonials.



The gold standard
of extreme pressure
chromatography hardware
and consumables.

UHPLC

EXP[®]

From the name you've trusted for over 30 years of precision innovation in HPLC accessories and consumables, EXP represents the culmination of a generation of research and development. High standards consistently guarantee that every product bearing the EXP trademark exemplifies our quality control, responsive customer service and expert technical support.

EXTREME PRESSURE

Optimize Technologies' EXP product family includes fittings, filters and packed-bed products which offer unparalleled convenience and ease of use through exciting new patented and patent-pending innovations. This advanced system is the first design to provide reusable hand-tight connections and hand-tight cartridge replacement for UHPLC. The innovations significantly accelerate challenging UHPLC applications and reduce costly instrument downtime.

REVOLUTIONARY FEATURES:

- EXP titanium/PEEK hybrid ferrule offering repeated zero-dead-volume connections, hand-tight to 8,700 psi or wrench-tight to 20,000 psi (1,400+ bar).
- EXP holders and cartridges with ultra-low internal swept volume and hand-tight cartridge changeover for use to 20,000 psi (1,400+ bar).

Our EXP components provide excellent protection with negligible impact on analyte retention and peak symmetry. The elegant design of the EXP line showcases sleek architecture for easy installation in restricted instrument compartments without compromising accessibility. Our commitment to exceed industry standards yields an entire EXP product family conservatively rated to 20,000+ psi (1,400+ bar). The EXP product line, are designed and manufactured in our facility in Oregon, USA.

100% of all Optimize EXP products are made in the USA from raw materials originating in the USA.
98% of all Optimize products are made in the USA from raw materials originating in the USA.

EXP® TITANIUM HYBRID FERRULE TECHNOLOGY

THE FOUNDATION OF THE EXP® FAMILY

Optimize Technologies recognizes the challenges faced by scientists and technicians in the constantly evolving field of chromatography and LC instrumentation. Ultra high pressure liquid chromatography presents an opportunity for innovative products.

In response to evolving UHPLC technologies, Optimize created the EXP Titanium PEEK Hybrid ferrule. The EXP and EXP2 ferrule adjusts to any 10-32, 6-40 or 6-32 port depth and can subsequently be removed and reused in a different port while still maintaining adjustability. The ferrule provides the necessary zero-dead-volume seal to allow connections beyond 20,000+ psi (1,400+ bar).

The EXP and EXP2 ferrule form the foundation of the EXP product line. The EXP ferrule is incorporated into the entire EXP product line, offering a wide array of applications. At Optimize, we strive to develop new products that are straight forward, yet elegant, solutions to daily issues in the lab.

A PERFECT SEAL WITH EVERY CONNECTION

Original **EXP®** Ferrule
for Stainless Steel

EXP®2 TI-LOK Ferrule
for **PEEKsil®**



PEEK

Proven sealing ability
beyond 20,000+ psi
(1,400+ bar).

TITANIUM

Enables the swage to be
released and reset.
Intended for many repeat
connections.



Advantages of the Original **EXP®** Ferrule

- Rated to 20,000+ psi (1,400+ bar)
- Tested to 30,000 psi
- No need to cut tubing to replace a swaged ferrule
- Auto-adjusting ZDV connection
- Intended for many repeat uses

Advantages of the **EXP®2** TI-LOK Ferrule

- All of the Original EXP Ferrule benefits (listed above)
- Perfect for PEEKsil, PEEK and Fused Silica Tubing
- Inverted Titanium Hybrid Ferrule geometry prevents delamination of PEEKsil tubing by bottom-of-the-port sealing



ULTRA HIGH PRESSURE
20,000+psi / 1,400+bar

A REVOLUTIONARY QUICK-CONNECT SYSTEM

- Hand-tight quarter-turn holder closure design
- Low volume/low dispersion interface for volume critical regions
- True zero-dead-volume connection
- In-line and direct-connect holder configurations
- Holder hardware is only plumbed once
- Hand-tight no tools needed
- Simple, innovative and easy to use

VERSATILITY

OPTI-LYNX was the first to introduce a low dispersion quick-connect system for HPLC and LC/MS. It is the most efficient solution for high-throughput and single instrument laboratories alike. The system is simple, fast and easy to use.

The OPTI-LYNX System is modular design providing the maximum in versatility for your instrument. OPTI-LYNX inserts are available as filters, guard columns, trap columns or analytical columns. The holder's end-caps feature interacting surfaces that are identical, with the holder tube as the only variable component. Install a guard column for one application and simply switch to a pre-column filter for the next. Use an in-line filter with different porosities and diameters just by changing the insert. Make and break flow paths for multiple applications or anywhere a break in flow is frequently required. OPTI-LYNX allows flexibility without the hassle of changing basic components.

At Optimize, our goal is to deliver ideal solutions to individual applications. For example, beyond HPLC, OPTI-LYNX is ideal for high temperature GPC and position-emitting radionuclide filtration. OPTI-LYNX is designed as a hardware platform to make applications easier and more efficient. For special OPTI-LYNX stationary phase requirements, custom dimensions or configurations, please contact us.

high-throughput labs with the need for replacing components with the utmost efficiency, to single instrument labs that enjoy the ease of use OPTI-LYNX offers - many have realized the advantages of the OPTI-LYNX quick-connect system.



MICRO OPTI-LYNX

OUR BEST IDEAS COME FROM
THE NEEDS OF OUR CUSTOMERS

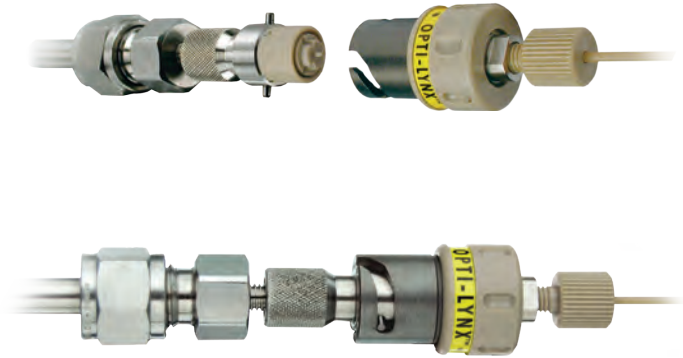

To change an OPTI-LYNX™ Insert, simply twist the holder
- no tools required.

HOW IT WORKS

With OPTI-LYNX, all it takes is a quarter-turn by hand to make or break tubing connections instantly. To make an OPTI-LYNX connection, two components - a slotted side and a pinned side - come together encapsulating the polymeric insert. The OPTI-LYNX System is useful and versatile because the polymeric insert can be a filter, trap column, guard column or even an analytical column. Almost any component, in the HPLC flow path, can be configured into an OPTI-LYNX insert.

"Problems with consistency and column longevity have been virtually eliminated since we started using OPTI-LYNX products. The Quick-Connect design makes changing columns fast and easy, eliminating the need for any tools."

Partner: Pfizer

FITTINGS, ADAPTERS & TUBING

Optimize offers a variety of compression fittings, adapters and tubing for making low, high and ultra high pressure LC connections. OPTI-LOK LP 1/4-28 fittings are the best choice for connecting into flat-bottomed low-pressure ports. For high pressure applications, OPTI-LOK 6K fittings are ideal for making solid, secure connections into any 10-32 port.

In response to evolving UHPLC technologies, Optimize delivers with the EXP Titanium PEEK Hybrid Ferrule. The ingenuity of the EXP and EXP2 Ferrule is designed to adjust to any 10-32, 6-40 or 6-32 port depth and can be removed and reused in a different port while still maintaining adjustability. The ferrule provides the necessary zero-dead-volume seal to allow connections beyond 20,000+ psi (1,400+ bar).

Our fittings and adapters are individually machined, never molded. Each fitting is individually inspected for the highest quality in the finished product. This process ensures consistent threading into fitting ports and longer thread life.

We also offer high and low pressure tubing in a number of diameters. Our stainless steel tubing is available pre-cut in a variety of lengths. Polymeric tubing can be purchased in bulk lengths and cut to size. We offer polymeric tubing in PEEK, PTFE and other materials.



GUIDE TO OPTIMIZE FITTINGS

	OPTI-LOK™	OPTI-LOK™	OEM	OPTI-LOK™	EXP®	EXP®2
	LP Fittings	6K Fittings	Fittings	Adapters	UHPLC Fittings	UHPLC Fittings
	Pg. 9	Pg. 10	Pg. 11	Pg. 12	Pg. 13	Pg. 14-18
Maximum Pressure	 LOW PRESSURE > 1000 PSI / > 70 BAR	 HIGH PRESSURE 6K PSI / 400 BAR	 HIGH PRESSURE 6K PSI / 400 BAR	 HIGH PRESSURE 6K PSI / 400 BAR	 ULTRA HIGH PRESSURE 20K+ PSI / 1400+ BAR	 ULTRA HIGH PRESSURE 20K+ PSI / 1400+ BAR
Thread Type(s)	1/4 - 28 M6 Metric	10 - 32 M6 Metric	1/4 - 28 10 - 32	1/4 - 28 10 - 32 Luer M6	6 - 32 6 - 40 10 - 32	6 - 32 6 - 40 10 - 32
Compatible Tubing Sizes (OD)	1/16 .100 1/8	1/16	1/16	Various	1/32 1/16	1/32 1/16
Hand-Tight	✓	✓	✓	✓	✓	✓
Products	Nuts Ferrules Unions Tees Plugs	Nuts with Integral Ferrules Nuts Ferrules Couplers Unions Tees Plugs	Nuts Ferrules Unions Compression Screws	Adapters	Nuts Ferrules Couplers	Nuts Ferrules Nuts with Integral Ferrules
Materials	PEEK ETFE PTFE PCTFE Acetal	PEEK PCTFE ACETAL Stainless Steel	PEEK Stainless Steel	PEEK	Titanium PEEK Stainless Steel	Titanium PEEK Stainless Steel

OPTI-LOK™ LOW PRESSURE FITTINGS

OPTI-LOK LP Fittings are an excellent choice for making low-pressure connections into 1/4-28 ports. Connections to flat-bottomed ports can be made using OPTI-LOK flat-bottomed ferrules for 1/16" or 1/8" tubing without the need for pre-flanged tubing ends. OPTI-LOK LP Fittings are precision machined to deliver leak-free, zero-dead-volume connections every time. We also offer 1/4-28 unions in various through-hole sizes for joining flat-bottom fittings.

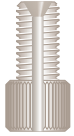

Nut (PEEK)

OPTI-LOK™ LP 1/4-28 Nuts & Ferrules for 1/16" OD Tubing

10-21-00290	Nut, PEEK	10-21-00293	Nut, White Acetal
10-21-00292	Nut, ETFE	10-21-00299	Nut, PTFE
10-21-00291	Nut, Long, PEEK	10-21-00296	Ferrule, PEEK
10-21-00295	Ferrule, ETFE	10-21-00300	Ferrule, PTFE



Ferrule (PEEK)

OPTI-LOK™ LP 1/4-28 Nuts & Ferrules for .100" OD Tubing

10-21-00283	Nut, White Acetal	10-21-00284	Nut, PEEK
10-21-00281	Ferrule, ETFE		

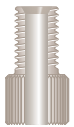

Nut (PEEK)

OPTI-LOK™ LP 1/4-28 Nuts & Ferrules for 1/8" OD Tubing

10-21-00307	Nut, PEEK	10-21-00305	Nut, Black Acetal
10-21-00310	Nut, White Acetal	10-21-00306	Nut, PCTFE
10-21-00309	Nut, ETFE	10-21-00317	Nut, PTFE
10-21-00308	Nut, Long, PEEK	10-21-00313	Ferrule, PEEK
10-21-00312	Ferrule, ETFE	10-21-00318	Ferrule, PTFE



Union (PEEK)

1/4-28 Unions

10-21-00323	Union, PEEK
10-21-00343	Union, Knurled with Wrench Flats, .050" Thru, PEEK

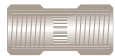

Union (PEEK)

1/4-28 Tee for 1/16" OD Tubing

10-21-00286	Tee, .062" Thru, PEEK
--------------------	-----------------------

OPTI-LOK™ LP 1/4-28 Plug

10-21-00326	Plug, PTFE
--------------------	------------



Plug (PTFE)

OPTI-LOK™ M6 METRIC NUTS & FERRULES

OPTI-LOK™ 6K PEEK Metric Fittings for 1/16" OD Tubing

10-22-00328	Nut, Knurled Head with Hex, PEEK
10-20-00269	Double Tight Ferrule, PEEK
10-22-00329	Nut, Knurled Head with Hex & Ferrules, 10/Pk



Double Tight Ferrule (PEEK)

OPTI-LOK™ LP Metric Fittings for 1/16" OD Tubing

10-22-00297	Nut, White Acetal	10-22-00301	Ferrule, Short, ETFE
--------------------	-------------------	--------------------	----------------------

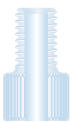

Nut (White Acetal)

OPTI-LOK™ LP Metric Fittings for 1/8" OD Tubing

10-22-00314	Nut, White Acetal	10-22-00315	Nut, Black Acetal
10-22-00319	Ferrule, Short, ETFE		

OPTI-LOK™ HIGH PRESSURE FITTINGS

OPTI-LOK Fittings are ideal for high-pressure connections with 1/16" OD tubing. All Optimize fittings are precision machined for optimal quality and thread consistency and are designed for trouble-free operation at pressures of up to 6,000 psi.

OPTI-LOK™ I 10-32 Hand-Tight Fittings with Integral Ferrule

SINGLES	10 PACK	
10-20-00258	10-20-00259	OPTI-LOK I, PCTFE
10-20-00264	10-20-00265	OPTI-LOK I, PEEK

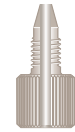

OPTI-LOK I (PEEK)

OPTI-LOK™ 6K 10-32 Nuts & Ferrules

SINGLES	10 PACK	
Nut Only	With Ferrules	
10-20-00268	10-20-00270	Knurled Head, PEEK
10-20-00271	10-20-00272	Hex Head, Short, PEEK
10-20-00275	10-20-00276	Hex Head, Long, PEEK
10-20-00273	10-20-00274	Knurled Head, with wrench-flat, SS
SINGLES	10 PACK	
10-20-00269	10-20-00518	Double Tight Ferrule, PEEK

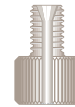

6K Knurled Head (PEEK)



6K Hex Head, Short (PEEK)

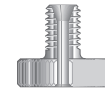

6K Knurled Head (SS)



Ferrule (PEEK)



Double Tight Ferrule (PEEK)

10-32 Couplers with 1/16" OD x .006" ID x 6cm SS Tubing

10-20-00263	Coupler, PCTFE
10-20-00266	Coupler, PEEK

Universal 10-32 Nuts & Ferrules for 1/16" OD Tubing

10-24-00367	Universal Nut, SS
10-24-00369	Universal Ferrule, SS
10-24-00370	Universal Ferrule, PEEK
10-24-00376	Universal SS Nuts with SS Ferrules, 10/Pk



Universal Nut (SS)

10-32 Unions for 1/16" OD Tubing

10-20-00261	PEEK Union, .010" Thru
10-20-00262	PEEK Union, .020" Thru
10-24-00375	Universal Union, with Nuts & Ferrules, .010" Thru, SS
10-24-00373	Universal Union, with Nuts & Ferrules, .020" Thru, SS
10-24-00371	Universal Union, with Nuts & Ferrules, .030" Thru, SS

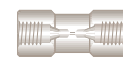

Union (PEEK)



Tee (PEEK)



Plug (White Acetal)

10-32 OPTI-LOK™ Plugs

SINGLES	10 PACK	
10-20-00251	10-20-00253	Plug, White Acetal
10-20-00255	10-20-00256	Plug, PEEK

OEM SPECIFIC FITTINGS

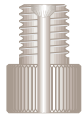

6K Nut
(PEEK)



Double Tight
Ferrule
(PEEK)



Nut (SS)



Ferrule
(PEEK)



Union
(SS)



Ferrule
(SS)

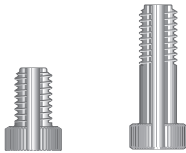

Nut
(SS)

Nut, Long
(SS)



Ferrule
(SS)

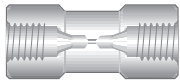

Union (SS)



Ferrule (PEEK)



Ferrule
(SS)

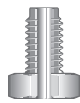

Compression
Screw (SS)

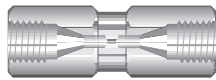

Union
(SS)



Ferrule
(PEEK)

SSI-Style 1/4-28 Fittings for 1/16" OD Tubing

10-20-00330	6K Nut, PEEK
10-20-00331	6K Nut & Ferrules, PEEK, 10/Pk
10-20-00269	Double Tight Ferrule, PEEK

Parker-Style 10-32 Fittings for 1/16" OD Tubing

40-24-01275	Nut, SS
40-24-01276	Nuts & Ferrules, SS, 10/Pk
40-24-01291	Ferrule, SS
40-24-01290	Ferrule, PEEK
40-24-01271	Union with Nuts & Ferrules, SS, .010" Thru
40-24-01273	Union with Nuts & Ferrules, SS, .020" Thru

Genuine Valco 10-32 Fittings for 1/16" OD Tubing

41-24-01277	Nut, SS
41-24-01281	Nuts & Ferrules, SS, 10/Pk
41-24-01278	Nut, Long, SS
41-24-01279	Ferrule, SS
41-24-01283	Union with Nuts & Ferrules, SS, .010" Thru
41-24-01280	Union with Nuts & Ferrules, SS, .030" Thru
41-24-01282	Ferrule, PEEK

Waters-Style 10-32 Fittings for 1/16" OD Tubing

		OEM #
39-24-01090	Compression Screw, SS	WAT005070
39-24-01091	Compression Screws & Ferrules, SS, 10/Pk	WAT025604
39-24-01291	Ferrule, SS, Single	WAT005063
39-24-01290	Ferrule, PEEK	WAT021817
39-24-01088	Union with Nuts & Ferrules, SS	WAT097332

OPTI-LOK™ ADAPTERS

OPTI-LOK Adapters offer maximum flexibility for making connections between 1/4-28, M6 (Metric), Luer and 10-32 fittings and ports. Adapters are available in a useful variety of thread-type combinations. All are precision machined from PEEK.

1/4-28 to 10-32

10-23-00350 1/4-28 Male  10-32 Parker Female

1/4-28 to Luer

10-23-00352 1/4-28 Male  Luer Male

10-23-00353 1/4-28 Male  Luer Female

1/4-28 to M6

10-23-00351 1/4-28 Male  M6 (Metric) Female

1/4-28 to Luer

10-23-00347 1/4-28 Female  Luer Male

10-23-00349 1/4-28 Female  Luer Female

1/4-28 to M6

10-23-00346 1/4-28 Female  M6 Female, with Web

10-23-00335 1/4-28 Female  10-32 Parker Female

M6 to 10-32

10-23-00357 M6 (Metric) Male  10-32 Parker Female

10-23-00355 M6 (Metric) Female  10-32 Parker Female

M6 to Luer

10-23-00363 M6 (Metric) Female  Luer Female

Luer to 10-32

10-23-00358 10-32 Parker Female  Luer Female

10-23-00359 10-32 Parker Female  Luer Male

ORIGINAL EXP® FITTING SYSTEM - SS TUBING

The EXP Fitting System is the premier adjustable nut and ferrule compression fitting for extreme high-pressure connections between 1/32", or 1/16" tubing and any 6-32, 6-40 or 10-32 port. EXP fittings are simple and versatile.

The patented Titanium Hybrid Ferrule integrates the resilience of titanium with the proven sealing ability of PEEK in a superb one-piece design. The Hybrid Ferrule provides a perfect seal with every connection. The swage can be released without tools to adjust to the different port depths of various hardware. This adjustability provides value through repeated zero-dead-volume connections with any port configuration.

EXP®2 FITTING SYSTEM - SS TUBING

Optimize introduces EXP2 - the next generation of EXP UHPLC fitting technology. Featuring a small 3/16" hex head EXP2 Nut, the new EXP2 Driver and the original Titanium Hybrid Ferrule, the EXP2 fittings offer hand-tight connections rated to 20,000 psi+. The EXP2 nuts are available with 6-32, 6-40 and 10-32 threads and are scaled down to allow for maximum working room in cramped spaces. The EXP2 Driver is a small, easy to use knurled torque driver which snaps onto the nuts for hand-tightening and loosening. The EXP2 Driver is slotted and can be removed from the nut and tubing after use.

Both the EXP and EXP2 Fitting Systems offer products which can be reused in different ports for the best possible connections. These products eliminate the need to cut off and replace swaged ferrules.

EXP® Titanium Hybrid Replacement Ferrules

15-24-03831	1/16" Titanium Hybrid Ferrule
15-24-03832	1/16" Titanium Hybrid Ferrules, 10/Pk
15-19-04242	1/32" Nano Titanium Hybrid Ferrule
15-19-04243	1/32" Nano Titanium Hybrid Ferrules, 10/Pk

Original EXP® Hand-Tight Fittings

15-20-03888	10-32 Hand-Tight Nut & 1/16" Titanium Ferrule
15-20-03930	10-32 Hand-Tight Nuts & 1/16" Titanium Ferrules, 10/Pk
15-19-04245	6-40 Hand-Tight Nut & 1/32" Titanium Hybrid Ferrule
15-19-04246	6-40 Hand-Tight Nuts & 1/32" Titanium Hybrid Ferrules, 10/Pk

Original EXP® Hand-Tight Coupler

15-20-04128	1/16" OD x 0.005" ID x 5cm Stainless Steel Tubing Includes 2 Original EXP Hand-Tight Fittings
--------------------	--

EXP® HEX Head Fittings

15-20-04120	10-32 Standard Hex Head Nut & Titanium Hybrid Ferrule
15-20-03834	10-32 Standard Hex Head Nuts & Titanium Hybrid Ferrules, 10/Pk
15-20-03840	10-32 Short Hex Head Nuts & Titanium Hybrid Ferrules, 10/Pk
15-20-03842	10-32 Long Hex Head Nuts & Titanium Hybrid Ferrules, 10/Pk

HAND-TIGHT



Original **EXP**® Hand-Tight

Hand-Tight to 8,700+ psi
Wrench-Tight to 20,000+ psi



New **EXP**®2 Hand-Tight

Hand-Tight or Wrench-Tight to 20,000+ psi

EXP® Fitting Advantages

- Available in Standard (1/16") and Nano (1/32") configurations
- Rated to 20,000+ psi (1,400+ bar)
- Tested to 30,000 psi
- Auto-adjusting zero-dead-volume connection
- Intended for many repeat uses
- Cost efficient with replaceable components

HEX HEAD

Wrench-Tight to 20,000+ psi



EXP®2 Hand-Tight Fitting Kits

Kits below include 2 EXP2 Nuts, 2 EXP Ferrules + 1 EXP2 Driver

15-20-04933 10-32 EXP2 Nuts & 1/16" Titanium Hybrid Ferrules

15-19-04961 6-40 EXP2 Nuts & 1/32" Titanium Hybrid Ferrules

15-19-04958 6-32 EXP2 Nuts & 1/32" Titanium Hybrid Ferrules

Kits below include 10 EXP2 Nuts, 10 EXP Ferrules + 1 EXP2 Driver

15-20-04924 10-32 EXP2 Nuts & 1/16" Titanium Hybrid Ferrules

15-19-04962 6-40 EXP2 Nuts & 1/32" Titanium Hybrid Ferrules

15-19-04959 6-32 EXP2 Nuts & 1/32" Titanium Hybrid Ferrules

FINALLY, A REUSABLE
UHPLC FITTING THAT WORKS
WITH ALL TUBING MATERIALS.
HASSLE FREE, NO SEPARATE
FERRULE TO LOSE.

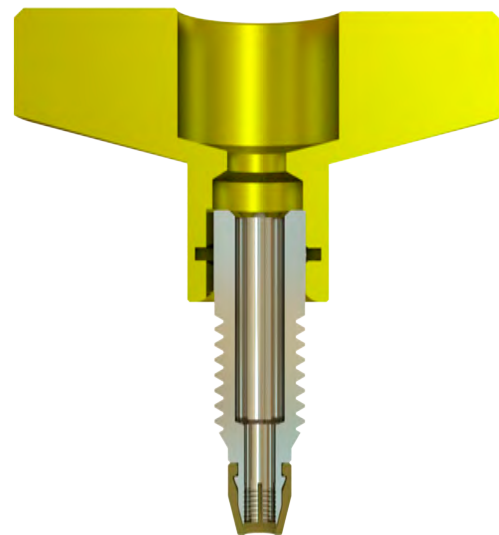

EXP[®]2 TI-LOK[™] FITTINGS



EXP[®]2 TI-LOK[™] FITTING

The EXP2 TI-LOK Fittings offer LC connections that can be hand-tightened to 18,000+ psi (1,250+ bar). The fittings are ideal for making HPLC and UHPLC connections that easily fit into tight spaces such as injection valves, column couplers, sample loops and column ovens.

Evolving from the original Titanium Hybrid Ferrule technology, the EXP2 TI-LOK Fittings feature built-in PEEK ferrules and threaded nuts precision machined from titanium. The new fittings combine the superior corrosion resistance and robustness of titanium with the sealing capability of PEEK. Utilizing a unique geometric design, the fittings firmly press tubing against the tube stop of any instrument port creating a zero-dead-volume (ZDV) connection. The ferrule does not permanently swage to the tubing, allowing for many repeat connections and the ability to adjust the tubing to different port depths. EXP2 TI-LOK Fittings are compatible with PEEK, PEEKsil, Hastelloy C and stainless steel tubing.

The fittings include an EXP2 Driver - a small, easy to use knurled torque driver that snaps onto the nuts for hand tightening and loosening. The EXP2 Driver is slotted and can be removed from the nut and tubing after use.

EXP[®]2 TI-LOK[™] ALL-IN-ONE (AIO) FITTING

Meet the newest addition to our EXP2 Fitting line. The AIO Fitting incorporates all of the features above with one distinct feature: a permanently-fixed driver. When tight spaces are not an issue, we recommend using the AIO Fitting.

HAND-TIGHT

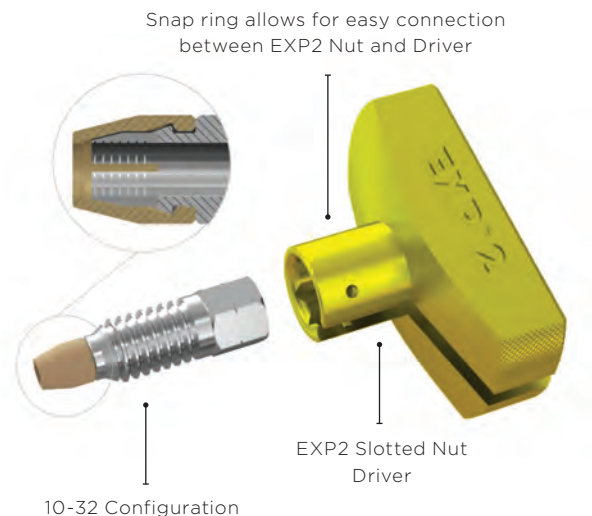

New **EXP[®]2** TI-LOK™

Hand-Tight to 8,700+ psi
Wrench-Tight to 18,000+ psi



New **EXP[®]2** TI-LOK™ AIO

Hand-Tight to 8,700+ psi
Wrench-Tight to 18,000+ psi

EXP[®]2 TI-LOK™ Hand-Tight Fittings

15-24-05204 10-32 TI-LOK Fittings, 2/Pk

15-24-05205 10-32 TI-LOK Fittings, 10/Pk

Each pack above Includes 1 EXP2 Driver

EXP[®]2 TI-LOK™ All-In-One (AIO) Hand-Tight Fittings

15-24-05253 10-32 AIO Fitting, 1/Pk

15-24-05254 10-32 AIO Fittings, 10/Pk

KEY FEATURES

- Hand-tight to 18,000+ psi (1,250+ bar)
- Titanium nut with integral PEEK ferrule
- One-piece fitting (no loose ferrules)
- Robust design with superior corrosion resistance
- Auto-adjusting zero-dead-volume connection
- Intended for many repeat uses
- Releases tubing for easy repositioning into different ports
- No need to cut tubing to replace a swaged ferrule
- Simple and versatile - can be used in all LC applications
- Compatible with PEEK, PEEKsil, Hastelloy C and stainless steel tubing

EXP[®]2 FITTING SYSTEM FOR 1/32" PEEKSIL[®] TUBING

The EXP2 Fittings with TI-LOK Ferrules offer UHPLC connections for PEEKsil tubing that seals to 15,000+ psi depending on the tubing I.D. For example, 50µm PEEKsil tubing can be hand-tightened to over 20,000 psi. The fittings are ideal for making Nano HPLC and UHPLC connections and easily fit into tight spaces such as injection valves, column couplers, sample loops and column ovens.

The EXP2 Titanium Hybrid TI-LOK Ferrules combine the robustness of titanium and the sealing capability of PEEK. Utilizing a unique inverted geometric design, the ferrules firmly press the PEEKsil tubing against the tube stop of any instrument port creating a zero-dead-volume (ZDV) connection. The titanium portion of the ferrule does not permanently swage to the tubing, allowing for many repeat connections and the ability to adjust the tubing to different port depths. Included with the TI-LOK Ferrules are the new EXP2 3/16" hex head nuts and EXP2 Driver. The nuts are available with 6-32 and 6-40 threads and have been scaled down to allow for maximum working room in cramped spaces. The EXP2 Driver is a small, easy to use knurled torque driver which snaps on to the nuts for hand-tightening and loosening. The EXP2 Driver is slotted and can be removed from the nut and tubing after use. EXP2 TI-LOK Fittings are available as kits with EXP2 nuts, TI-LOK Ferrules and EXP2 Driver.

The combination of bottom-of-the-port sealing, Titanium Hybrid technology and precision manufacturing make EXP2 Fittings the best choice for any standard or nano UHPLC and UHPLC/MS application.

EXP[®]2 Hand-Tight Fitting Kits

Kits below include 2 EXP2 Nuts, 2 EXP2 TI-LOK Ferrules + 1 EXP2 Driver

15-19-04931 6-40 EXP2 Nuts & 1/32" TI-LOK Ferrules

15-19-04930 6-32 EXP2 Nuts & 1/32" TI-LOK Ferrules

Kits below include 10 EXP2 Nuts, 10 EXP2 TI-LOK Ferrules + 1 EXP2 Driver

15-19-04927 6-40 EXP2 Nuts & 1/32" TI-LOK Ferrules

15-19-04929 6-32 EXP2 Nuts & 1/32" TI-LOK Ferrules

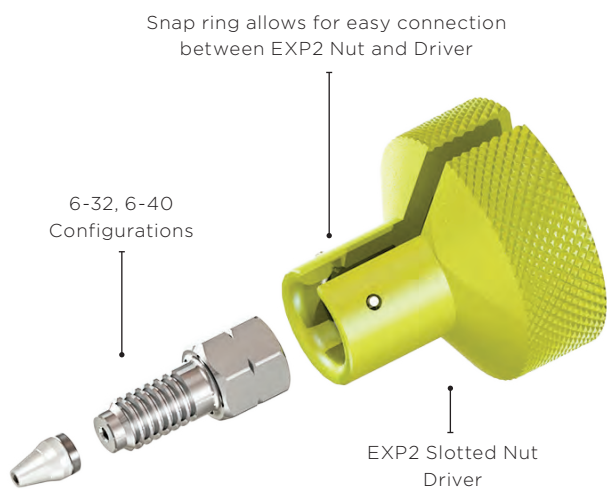

Advantages of EXP² fittings for PEEKSIL[®]

- Rated Hand-Tight to 20,000+ psi (1,400+ bar)
- Auto-adjusting, zero-dead-volume connection
- Extremely robust one-piece ferrule design
- Intended for many repeat uses
- Cost efficient with replaceable components
- Perfect for standard or nano UHPLC and UHPLC/MS

TI-LOK Ferrule incorporates inverted Titanium + PEEK Hybrid design



TI-LOK Ferrule technology prevents delamination of PEEKsil tubing by bottom-of-the-port sealing

3/16" OD
PTFE

1/8" OD
PTFE

.100" OD
PTFE

1/16" OD
PTFE

1/16" OD
ETFE

1/8" OD
ETFE

TUBING

PTFE TUBING

1/16" Outside Diameter PTFE Tubing

10-15-00214	1/16" OD x .010" ID x 10 ft
10-15-00220	1/16" OD x .020" ID x 10 ft
10-15-00221	1/16" OD x .020" ID x 50 ft
10-15-00226	1/16" OD x .030" ID x 10 ft
10-15-00227	1/16" OD x .030" ID x 50 ft
10-15-00232	1/16" OD x .040" ID x 10 ft
10-15-00233	1/16" OD x .040" ID x 50 ft

.100" Outside Diameter PTFE Tubing

10-15-00205	.100" OD x .040" ID x 10 ft
10-15-00206	.100" OD x .040" ID x 50 ft

1/8" Outside Diameter PTFE Tubing

10-15-00238	1/8" OD x .062" ID x 10 ft
10-15-00240	1/8" OD x .062" ID x 50 ft

3/16" Outside Diameter PTFE Tubing

10-15-00243	3/16" OD x .125" ID x 10 ft
10-15-00245	3/16" OD x .125" ID x 50 ft

ETFE TUBING

1/16" Outside Diameter ETFE Tubing

10-14-00193	1/16" OD x .010" ID x 10 ft
10-14-00194	1/16" OD x .010" ID x 50 ft
10-14-00196	1/16" OD x .020" ID x 10 ft
10-14-00197	1/16" OD x .020" ID x 50 ft
10-14-00199	1/16" OD x .030" ID x 10 ft
10-14-00200	1/16" OD x .030" ID x 50 ft

1/8" Outside Diameter ETFE Tubing

10-14-00202	1/8" OD x .062" ID x 10 ft
10-14-00203	1/8" OD x .062" ID x 50 ft

TUBING

OPTI-PEEK™ TUBING

1/16" Outside Diameter PEEK Tubing

10-13-00168	1/16" OD x .006" ID x 10 ft
10-13-00170	1/16" OD x .006" ID x 50 ft
10-13-00175	1/16" OD x .010" ID x 10 ft
10-13-00177	1/16" OD x .010" ID x 50 ft
10-13-00183	1/16" OD x .020" ID x 10 ft
10-13-00186	1/16" OD x .020" ID x 50 ft
10-13-00187	1/16" OD x .030" ID x 10 ft
10-13-00191	1/16" OD x .030" ID x 50 ft
10-13-00179	1/16" OD x .040" ID x 10 ft
10-13-00181	1/16" OD x .040" ID x 50 ft



Plastic Tubing Cutter

1/16" OD PEEK

STAINLESS STEEL PRE-CUT TUBING

1/16" Outside Diameter

10-12-00145	1/16" OD x .006" ID x 6 cm
10-12-00143	1/16" OD x .006" ID x 10 cm
10-12-00144	1/16" OD x .006" ID x 20 cm
10-12-00141	1/16" OD x .006" ID x 10 ft
10-12-00151	1/16" OD x .010" ID x 6 cm
10-12-00148	1/16" OD x .010" ID x 10 cm
10-12-00149	1/16" OD x .010" ID x 20 cm
10-12-00150	1/16" OD x .010" ID x 30 cm
10-12-00146	1/16" OD x .010" ID x 10 ft
10-12-00154	1/16" OD x .020" ID x 10 cm
10-12-00155	1/16" OD x .020" ID x 20 cm
10-12-00156	1/16" OD x .020" ID x 30 cm
10-12-00152	1/16" OD x .020" ID x 10 ft
10-12-00162	1/16" OD x .030" ID x 6 cm
10-12-00160	1/16" OD x .030" ID x 10 cm
10-12-00161	1/16" OD x .030" ID x 20 cm
10-12-00158	1/16" OD x .030" ID x 10 ft
10-12-00165	1/16" OD x .040" ID x 10 cm
10-12-00166	1/16" OD x .040" ID x 20 cm
10-12-00163	1/16" OD x .040" ID x 10 ft



Stainless Steel Tubing Cutter

1/16" OD Stainless Steel

TUBING CUTTERS

10-10-00139	Plastic Tubing Cutter
10-10-00140	Stainless Steel Tubing Cutter

Optimize stainless steel tubing is pre-cut and electropolished to ensure square, burr-free ends and is passivated prior to shipment.

FILTRATION

Keeping particulates out of the flow path prevents premature wear on vital components, drastically reducing the need for costly replacements or repairs. A holistic approach to filtration addresses potential particulates throughout the solvent flow path and leads to consistent and efficient chromatography. Generally, there are three critical areas where filtration is necessary.

Solvent Reservoir

While the availability of HPLC-grade solvents diminishes the need for pre-filtering, it is imperative that a filtration device be installed in the reservoir. Placing a filter in the reservoir is an economical way to filter particles that may result from buffer salt precipitation, airborne dust, improperly cleaned glassware, or microbial contamination; none of which are remedied by the use of HPLC-grade solvents.

In-line

The frictional forces generated at the piston/seal interface inevitably lead to particulate shedding. Placement of a filtering element between the pump and injector/autosampler removes the particulates, preventing problems with downstream components and costly downtime.

Pre-Column / Direct Connect

Many things contribute to particulates in the post-injector region: incompatibilities between sample matrix and mobile phase, septa coring from the sample needle and shedding from moving parts in the injector, etc. Use of a low-impact, pre-column filter removes these particulates from the flow path, saving your analytical column and detector from deleterious effects.

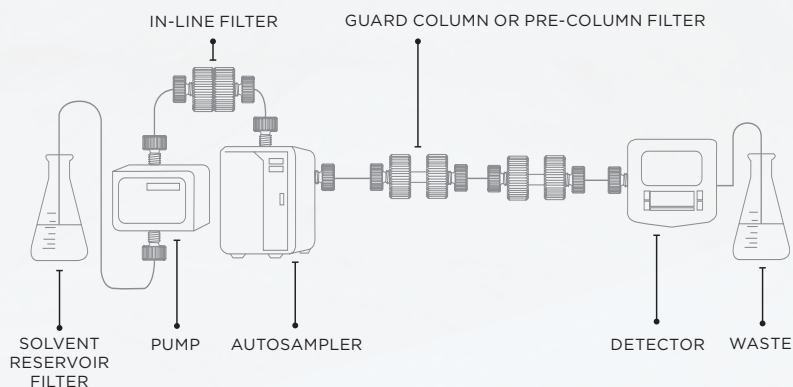



GUIDE TO OPTIMIZE FILTERS

	OPTI-SOLV [®]	OPTI-SOLV [®]	OPTI-SOLV [®]	OPTI-SOLV [®]	OPTI-SOLV [®]	OPTI-LYNX™2	EXP [®]	EXP [®] 2
	Solvent Reservoir Filters	In-Line Filters	Mini Filter	Micro Filter	Nano Filter	Filter	Stem Filter	Pre-Column & In-Line Filter
	Pg. 23	Pg. 24	Pg. 25	Pg. 26	Pg. 26	*see below	Pg. 27	Pg. 28
Maximum Pressure	N/A	 HIGH PRESSURE 6K PSI / 400 BAR	 HIGH PRESSURE 6K PSI / 400 BAR	 HIGH PRESSURE 6K PSI / 400 BAR	 HIGH PRESSURE 6K PSI / 400 BAR	 HIGH PRESSURE 6K PSI / 400 BAR	 ULTRA HIGH PRESSURE 20K+ PSI / 1400+ BAR	 ULTRA HIGH PRESSURE 20K+ PSI / 1400+ BAR
Porosities Available	2µm 10µm	.2µm .5µm 2µm	.5µm 2µm 5µm	.5µm 1µm 2µm 10µm	.5µm	***	.2µm .5µm	.2µm .5µm
Depth Filter				✓		✓		✓
Swept (Internal) Volume	N/A	<6µL	1.4µL	<200nL	50nL	1.4µL	.27µL	1.4µL
Configurations	Solvent Reservoir	In-Line	Direct-Connect / Pre-Column	Direct-Connect / Pre-Column	Direct-Connect / Pre-Column	In-Line & Pre-Column	Direct-Connect / Pre-Column	In-Line & Pre-Column
Auto Adjusting (ZDV) Port Connection	N/A	N/A	✓ Floating	✓ Floating	✓ Floating	✓ Spring-loaded	✓ Floating	✓ Spring-loaded
Holder or All-In-One (AIO) Disposable	AIO	Holder	AIO	AIO	AIO	Holder	Holder	Holder
Holder Fittings Included		✓				✓	✓	✓
Hand-Tight Holder & Cartridge Change	✓	✓	✓	✓	✓	✓	✓	✓

* Please contact Optimize for pressure rating and further product details.

OPTI-SOLV® SOLVENT RESERVOIR FILTERS

OPTI-SOLV Reservoir Filters have a unique conical design inside the filter housing to prevent air bubbles from getting trapped and disturbing your analysis.

A solid PTFE body keeps the OPTI-SOLV Reservoir Filter in the base of the bottle where a bottom-mounted titanium frit provides unrestricted solvent access. The Optimize design makes installation as simple as possible – no tools or fittings required.



Biocompatible OPTI-SOLV® Analytical Reservoir Filters

SINGLES		5 PACK	
10-04-00079	10-04-00080	2µm	1/16" OD Tubing
10-04-00081	10-04-00082	10µm	
10-04-00047	10-04-00050	2µm	1/8" OD Tubing
10-04-00051	10-04-00053	10µm	

Reservoir Filters with Tube Stem

SINGLES		5 PACK	
10-04-00071	10-04-00072	2µm	1/16" ID Tubing
10-04-00073	10-04-00074	10µm	
10-04-00115	10-04-00119	2µm	1/8" ID Tubing
10-04-00111	10-04-00114	10µm	

Reservoir Filter with Tube Stem

4 PACK			
10-04-03151	10µm	1/8" ID Tubing	OEM# WAT025531

Reservoir Filters with tube stems are made with Hastelloy C® for maximum corrosion resistance and inertness.



OPTI-SOLV® IN-LINE FILTERS



Installed between the pump and injector/autosampler, the OPTI-SOLV in-line filter prevents damage to downstream components avoiding both instrument downtime and labor.

Simply hand-tighten the PEEK holder to make a high-pressure seal. For those who prefer wrenches, a wrench-tight stainless steel version is available. The user-friendly designs are well suited for a number of applications such as high temperature environments where quick changes are imperative.



PEEK "GORILLA GRIP" HAND-TIGHT HOLDER



STAINLESS STEEL (SS) WRENCH-TIGHT HOLDER



FILTER ELEMENT

OPTI-SOLV® In-Line Filter Kits

Kits below include Holder, Fittings and 2 Filter Elements

10-04-02372	0.2µm, In-Line Solvent PEEK, Hand-Tight Holder
10-04-02371	0.2µm, In-Line Solvent, Wrench-Tight Holder
10-04-00386	0.5µm, In-Line Solvent PEEK, Hand-Tight Holder
10-04-00383	0.5µm, In-Line Solvent, Wrench-Tight Holder
10-04-00391	2µm, In-Line Solvent PEEK, Hand-Tight Holder
10-04-00390	2µm, In-Line Solvent, Wrench-Tight Holder

OPTI-SOLV® In-Line Filter Holders

10-04-03685	In-Line Solvent PEEK Hand-Tight Holder
10-04-03686	In-Line Solvent Stainless Steel (SS) Wrench-Tight Holder

OPTI-SOLV® Filter Elements (Frits)

10-04-02370	0.2µm, 0.187" Dia. Filter, 10/Pk
10-04-03699	0.5µm, 0.062" Dia. Filter, 10/Pk
10-04-03701	0.5µm, 0.125" Dia. Filter, 10/Pk
10-04-00100	0.5µm, 0.187" Dia. Filter, 10/Pk
10-04-03700	2µm, 0.062" Dia. Filter, 10/Pk
10-04-03702	2µm, 0.125" Dia. Filter, 10/Pk
10-04-00103	2µm, 0.187" Dia. Filter, 10/Pk

"We have been using OPTI-SOLV In-Line Filters for several years in our high-throughput LC/MS Analysis of ADME screening samples."

Partner: Pfizer ADME Technology Group

Two-Piece PEEK or Stainless Steel Holders

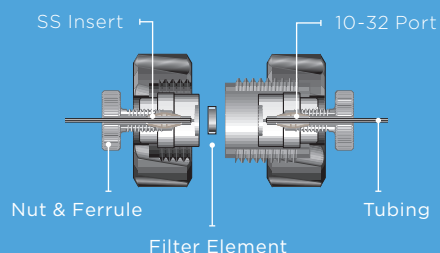

The OPTI-SOLV's unique swivel design allows frits to be changed without removing the connecting tubing. Just plumb the holder once and leave it.

OPTI-SOLV® MINI FILTER

The OPTI-SOLV Mini Filter provides low-impact filtration in a package no larger than a finger-tight fitting. Use the Mini Filter to extend the life of analytical columns or before mass spectrometers as a last line of defense against debris.

Perfect zero-dead-volume connections are obtained every time with the patented automatic tube stop depth adjustment. Unique depth-filtering elements allow for greater capacity with no band spreading or loss of performance. The efficient design requires no holder and threads directly into any 10-32 port.

THE OPTI-SOLV® MINI, MICRO & NANO FILTERS AUTOMATICALLY ADJUST TO FIT ALL BRANDS OF COLUMNS.

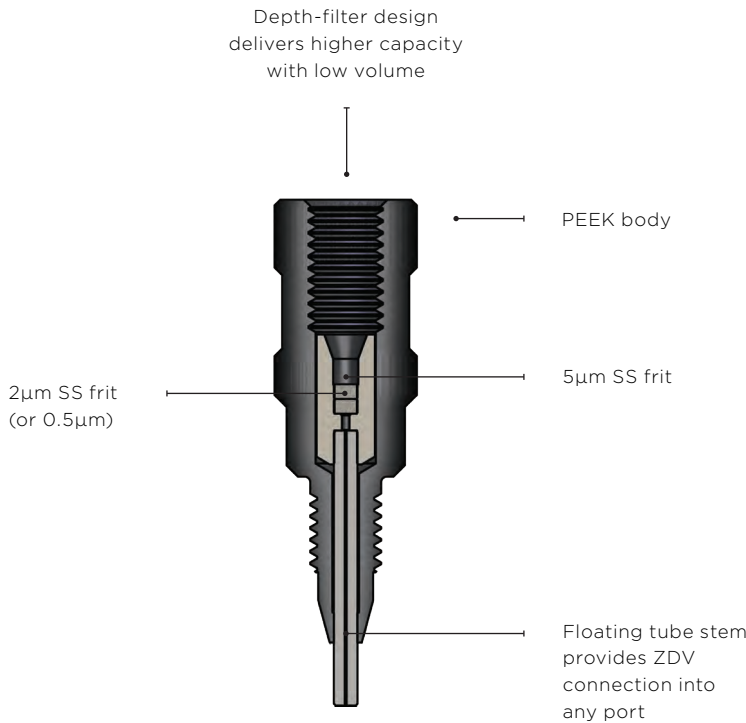

OPTI-SOLV® Mini Filters

10-04-00095	OPTI-SOLV Mini Filter, 0.5µm, 5/Pk
10-04-00097	OPTI-SOLV Mini Filter, 2.0µm, 5/Pk
10-04-02768	OPTI-SOLV Mini Filter, 5.0µm, 5/Pk

OPTI-SOLV® MICRO FILTER



For volume critical filtering needs, Optimize offers the OPTI-SOLV Micro Filter. Based on the design that made the Mini Filter successful, the Micro Filter cuts the internal volume to less than 200nL while retaining the ease of use and functionality of the Mini Filter.

The Micro Filter is designed to be used in today's low volume, high sensitivity chromatographic applications as a last line of defense against debris. As with all Optimize column protection products, the OPTI-SOLV Micro Filter features a zero-dead-volume connection utilizing patented floating stem (auto-adjusting) technology.

OPTI-SOLV® Micro Filters

10-04-03707	OPTI-SOLV Micro Filter, 10µm, 5/Pk
10-04-03357	OPTI-SOLV Micro Filter, 1.0µm, 5/Pk
10-04-03389	OPTI-SOLV Micro Filter, 2.0µm, 5/Pk
10-04-03621	OPTI-SOLV Micro Filter, 0.5µm, 5/Pk

OPTI-SOLV® Biocompatible Micro Filters

10-04-03936	OPTI-SOLV Biocompatible Nano Filter, 0.5µm, 5/Pk Wetted materials: PEEK and titanium
--------------------	---

OPTI-SOLV® NANO FILTER

The OPTI-SOLV Nano Filter cuts the internal volume down even further. With less than 50nL of internal volume, the OPTI-SOLV Nano Filter is ideal for mass spectrometry to protect electrospray and nanospray tips from clogging with debris.

OPTI-SOLV® Nano Filter

10-04-03625	OPTI-SOLV Nano Filter, 0.5µm, 5/Pk
--------------------	------------------------------------

OPTI-SOLV® Biocompatible Nano Filter

10-04-03939	OPTI-SOLV Biocompatible Nano Filter, 0.5µm, 5/Pk Wetted materials: PEEK and titanium
--------------------	---

The OPTI-SOLV® Mini, Micro and Nano filters are easy to use and perform exceptionally well for volume-critical applications.

Advantages of the OPTI-SOLV® Mini, Micro and Nano Filters:

- Designed to filter out particles to extend column life
- Perfect Zero-Dead-Volume connections every time
- Floating stem automatically adjusts to any depth port
- Hand-tight - no tools required
- Rated to 6,000 psi



Modern UHPLC and UHPLC/MS instrumentation pushes the envelope in fluid handling with tiny passages and extremely high pressures. At any time, an unprotected system is a stray 1µm seal fragment away from failure, loss of data continuity and subsequent troubleshooting and repair. Safeguard your system through filtration.

The EXP Stem Filter features a choice of frit porosities integrated with patented auto-adjusting stem for repeated ZDV connections with any 10-32 port. The entire filter stem and reusable holder are only slightly larger than a standard HPLC fitting. The slim architecture allows it to easily fit into crowded instrument compartments, tightly-spaced injection ports and anywhere else an extra level of protection against clogging and contamination is necessary. The EXP Stem Filter is an ideal solution to protect expensive UHPLC columns, injectors, autosamplers, and MS electrospray tips without extra-column effects.

When tightened by hand, the EXP Stem Filter seals to 8,700+ psi. The reusable holder hardware also incorporates wrench flats to enable flawless sealing to 20,000+ psi (1,400+ bar). The EXP Stem Filter is the ultimate low-impact protection for expensive UHPLC and MS equipment, assuring trouble-free performance allowing the user to concentrate on the data, not troubleshooting.

Advantages of the EXP® Stem Filter

- Approved for use at 20,000+ psi (1,400+ bar)
- Hand-tight and wrench-tight configuration
- Reusable holder intended for many repeat uses
- Auto-adjusting ZDV connections
- Low-dispersion cartridges
- Custom volumes/porosities available
- Ultra-low .27µL total swept volume

actual size

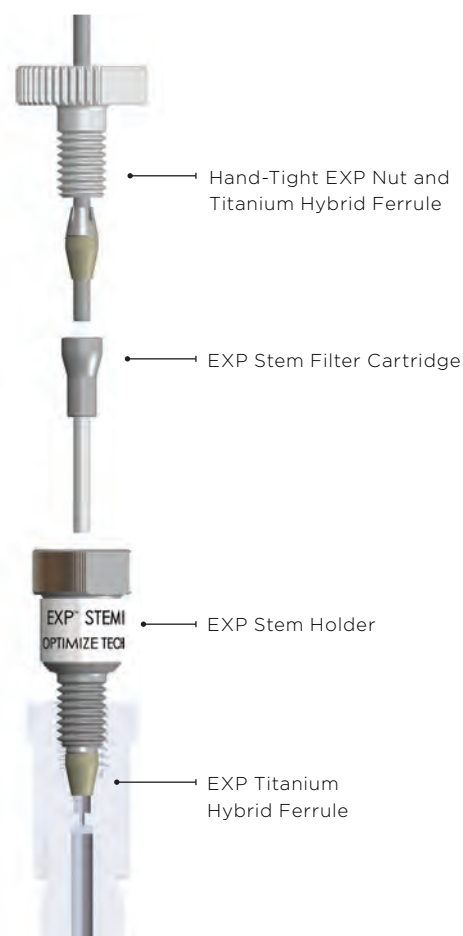

EXP® Stem Filter Kit

Kits below include Holder, 3 Stem Filter Cartridges and Fittings

15-04-04122 0.2µm, EXP Stem Filter Kit

15-04-04123 0.5µm, EXP Stem Filter Kit

EXP® Stem Filter Cartridges

15-04-04117 0.2µm, EXP Stem Filter Cartridge, 5/Pk

15-04-04119 0.5µm, EXP Stem Filter Cartridge, 5/Pk



The EXP2 Pre-Column and In-Line Hand-Tight Filters are ideal for protecting small-particle UHPLC columns and systems at extreme pressures. Such techniques analyze samples in the most demanding applications, decreasing the life of expensive hardware. EXP2 Filters help extend the life of a UHPLC system and protect your investment without sacrificing performance. Free-turn[®] architecture allows the user to change cartridges by hand without breaking fluid connections on the holder inlet/outlet.

EXP2 Pre-Column Filter holders are available with Titanium Hybrid Ferrules for easy direct connection to any 10-32 port. The filter holder is a complete package and includes fittings to provide repeated zero-dead-volume connections.

Advantages of EXP[®]2 Filters

- Approved for use at 20,000+ psi (1,400+ bar)
- Hand-tight filter replacement - no tools needed
- Auto-adjusting ZDV connections
- Custom volumes/porosities available
- Low-volume, low-dispersion cartridges
- Hardened stainless steel end cap eliminates galling
- New design offers more cost efficient cartridges

EXP[®]2 Filter Holders

15-04-05242 EXP2 Pre-Column Filter Holder

15-04-05258 EXP2 In-Line Filter Holder

The above holders include fittings

EXP[®]2 Filter Cartridges

15-04-05259 2µm, 3mm EXP2 Filter Cartridge, 5/Pk

15-04-05261 0.5µm, 3mm EXP2 Filter Cartridge, 5/Pk

15-04-05263 0.2µm, 3mm EXP2 Filter Cartridge, 5/Pk

15-04-05260 2µm, 3mm EXP2 Filter Cartridge, 10/Pk

15-04-05262 0.5µm, 3mm EXP2 Filter Cartridge, 10/Pk

15-04-05264 0.2µm, 3mm EXP2 Filter Cartridge, 10/Pk

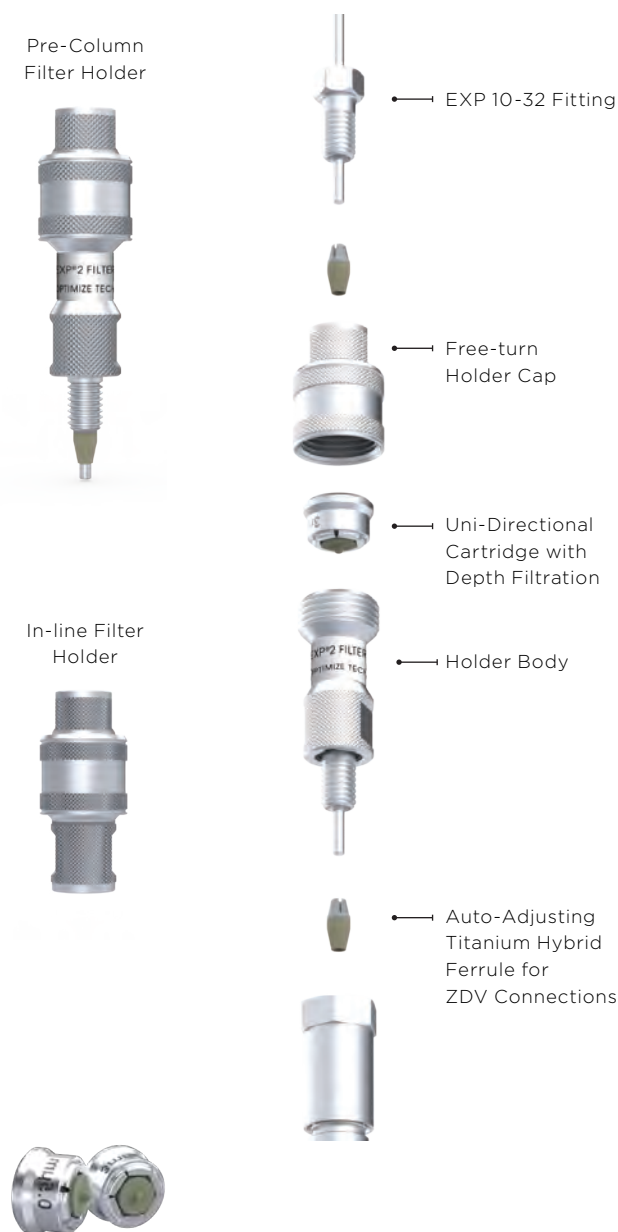

TRAP COLUMNS

Trapping is a chromatography technique that allows for the concentration or purification of a sample. A trap cartridge is a packed column bed loaded with a material to create desirable conditions for separating the target compound from the rest of the sample matrix. This is accomplished by selecting a packing material that has a strong affinity for the target compound causing the analyte to be retained in the trap while the rest of the sample matrix flows through; or by selecting a material which has no affinity for the target compound but that binds other unwanted matrix components such as salts, detergents and contaminants.

Trap columns are uni-directional or bi-directional and are used either on-line or off-line for sample pre-concentration and clean-up. Trap column bed materials need not be similar to the primary LC column bed materials and can be selected based on sample clean-up needs. Desirable characteristics of a trap include low back pressure, bi-directional flow, a robust bed, the ability to regenerate the packed bed and low swept volume.

To learn more about LC or LC/MS off-line and on-line trapping, please refer to the LC Trapping Guide on pages 75-87.

TRAP CARTRIDGE SELECTION GUIDES

In an effort to consolidate part numbers, options and associated stationary phases, trap cartridge part numbers are condensed in tables on the following pages .

HOW TO USE OUR SELECTION GUIDES

Find the five digits matching the required trap dimensions. Then, identify the two letter packing code for the phase.

Example: a single 5 μ L cartridge with SCX phase will be part number 10-04815-TP.

	Bed Volume	Dimensions	Dimension Code	Code	Phase
SINGLES	0.5 μ L	0.5 x 2mm	0 4 8 1 3	T P	SCX
	5 μ L	1 x 8mm	0 4 8 1 5	T Q	Small Molecule
	50 μ L	3 x 8mm	0 4 8 1 7	E S	Custom

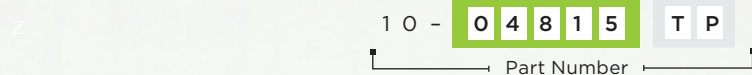



GUIDE TO OPTIMIZE TRAP COLUMNS

	OPTI-TRAP™	OPTI-LYNX™	OPTI-LYNX™2	EXP*2	EXP*	EXP*
	Column	Micro Trap	Trap	Nano Trap	Stem Trap	Trap Column
	pg. 31	pg. 32	*see below	pg. 33	pg. 35	pg. 37
Maximum Pressure	 MEDIUM PRESSURE 1.5K PSI / 100 BAR	 HIGH PRESSURE 6K PSI / 400 BAR	 HIGH PRESSURE *see below	 ULTRA HIGH PRESSURE 20K+ PSI / 1400+ bar	 ULTRA HIGH PRESSURE 20K+ PSI / 1400+ BAR	 ULTRA HIGH PRESSURE 20K+ PSI / 1400+ BAR
Bed Volumes Available	0.5µL 5µL 50µL	4µL 10µL 20µL 40µL	20µL 40µL 100µL	.12µL .30µL 1µL	.17µL .33µL .68µL 1.5µL 2.6µL	4µL 10µL 20µL 40µL 100µL >100µL / Custom
Custom Packing Available	✓	✓	✓	✓	✓	✓
Holder Configurations	In-Line & Manual (off-line)	In-Line & Direct-Connect	In-Line & Direct-Connect	In-Line & Direct-Connect	In-Line & Direct-Connect	In-Line & Direct-Connect
Hand-Tight Holder Hand-Tight Cartridge Change	✓	✓	✓	✓	✓	✓
Holder Thread Type(s)	10-32	10-32	10-32	6-32 6-40 10-32	10-32	10-32
Holder Fittings Included	✓	✓				✓
Auto Adjusting (ZDV) Port Connection	N/A	Spring-loaded	Spring-loaded	Spring-loaded	Floating	Spring-loaded
Biocompatible Option	✓	✓				

* Please contact Optimize for pressure rating and further product details.

The OPTI-TRAP is a bi-directional trap cartridge system which is used individually or in a series for sample concentration and purification. The OPTI-TRAP system features a durable biocompatible trap holder assembly made of either PEEK (0.5µL configuration) or stainless steel with a PEEK flow path (5µL and 50µL configurations). OPTI-TRAPS feature low back pressure and are loaded and eluted manually with a syringe or on-line when plumbed into the sample injection valve. OPTI-TRAPS include titanium frits for full biocompatibility.

OPTI-TRAP™ Advantages

- Rated hand-tight for use up to 1,500 psi (100 bar)
- Low back pressure, for syringe loading/eluting or on-line trapping
- Transparent cartridge allows for visual inspection of bed
- Bi-directional cartridge for flushing and bed regeneration
- Color coded band for identification of packing material
- PEEK and titanium flow path for biocompatibility



Manual Holder Kit

Capillary (.5µL): **10-02-04749**

Micro (5µL): **10-02-04745**

Macro (50µL): **10-02-04747**



In-Line Capillary Holder Kit (0.5µL)

Includes fittings and tubing

10-02-04808



In-Line Micro / Macro Holder Kit (5 & 50µL)

Includes fittings and tubing

10-02-04751

OPTI-TRAP™ CARTRIDGE SELECTION GUIDE

		Bed Volume	Dimensions	Load Rate (mL/min)	Dimension Code	Code	Phase	Band
SINGLES	Cap	0.5µL	0.5 x 2mm	0.005 - 0.020	0 4 8 1 3	T M	Protein	Black
	Micro	5µL	1 x 8mm	0.05 - 0.20	0 4 8 1 5	T N	Peptide	Green
	Macro	50µL	3 x 8mm	0.5 - 2	0 4 8 1 7	T O	NID	Blue
6 PACKS	Cap	0.5µL	0.5 x 2mm	0.005 - 0.020	0 4 8 1 4	T P	SCX	Orange
	Micro	5µL	1 x 8mm	0.05 - 0.20	0 4 8 1 6	T Q	Small Molecule	Purple
	Macro	50µL	3 x 8mm	0.5 - 2	0 4 8 1 8	E S	Custom	Gray

To calculate the approximate sample capacity of each trap cartridge, we recommend using the ratio 4µg/1µL of bed volume. For more information about how to use this table, please see page 29.



EXP[®]2 NANO TRAP DIRECT CONNECT & IN-LINE HOLDERS



Advantages of the EXP[®]2 Nano Trap

- Rated to 20,000+ psi (1,400+ bar)
- Reduced column volume for superior performance
- For multi-directional and uni-directional trapping
- Lowest swept volume design for peak sharpness

EXP[®]2 Nano Trap Holders

15-02-05036	EXP2 Nano Trap Direct Connect Holder Includes EXP Fittings, connects to any 10-32 port
15-02-05107	EXP2 Nano Trap In-Line Holder Kit with 10-32 Threads Includes 1/16" PEEKsil Tubing and 4 EXP2 Fittings
15-02-05088	EXP2 Nano Trap In-Line Holder Kit with 6-40 Threads Includes 1/16" PEEKsil Tubing and 4 EXP2 Fittings

EXP® STEM TRAP



The entire EXP Stem Trap and reusable holder are only slightly larger than a standard HPLC fitting. The slim architecture allows it to easily fit into crowded instrument compartments or to connect directly to tightly-spaced injection ports. When tightened by hand, the EXP Stem Trap seals to 8,700+ psi. All configurations incorporate wrench-flats to enable flawless sealing to 20,000+ psi (1,400+ bar). The unique packed floating stem installs directly into any 10-32 port and automatically adjusts to provide a perfect ZDV connection.

Specialized features, patented technology, precision engineering and state-of-the-art manufacturing make the new EXP Stem Trap an unbeatable choice for ultra high-pressure trapping applications.

EXP® Stem Holder

15-02-03996 EXP Stem Holder
Includes fittings



actual size

EXP® STEM TRAP SELECTION GUIDE

	Bed Volume	Load Rate (mL/min)	Dimensions	Dimension Code	Code	Phase	
STEM TRAP KIT	0.17µL	0.005 - 0.1	125µm x 13.5mm	0 3 9 9 7	H P H Q H R	C18 C8 HILIC	5µm HALO®
REPLACEMENT STEMS (3 PK)	0.17µL			0 3 9 9 2	H S H T H U H V	Phenyl-Hexyl PFP ES-CN Penta-HILIC	
STEM TRAP KIT	0.33µL	0.01 - 0.25	180µm x 13.5mm	0 4 0 0 3			
REPLACEMENT STEMS (3 PK)	0.33µL			0 4 0 0 1	H A H B H D H E H F H N	C18 C8 HILIC RP-Amide Phenyl-Hexyl Peptides ES-C18	
STEM TRAP KIT	0.68µL	0.02 - 0.5	250µm x 13.5mm	0 4 0 0 9			
REPLACEMENT STEMS (3 PK)	0.68µL			0 4 0 0 8			
STEM TRAP KIT	1.5µL	0.05 - 1	350µm x 13.5mm	0 4 0 1 5	H G H H H I H J H K H L H M	C18 C8 C4 HILIC Phenyl-Hexyl SAX SCX	3µm EXP®
REPLACEMENT STEMS (3 PK)	1.5µL			0 4 0 1 4			
STEM TRAP KIT	2.6µL	0.10 - 2	500µm x 13.5mm	0 4 0 2 1			
REPLACEMENT STEMS (3 PK)	2.6µL			0 4 0 2 0	E S	Custom	

1 5 -

Part Number

To calculate the approximate sample capacity of each trap cartridge, we recommend using the ratio 4µg/1µL of bed volume. For more information about how to use this table, please see page 29.

STEM TRAP KIT



Holder



Fitting



Stems

Advantages of the
EXP® Stem Trap

- Rated to 20,000+ psi (1,400+ bar)
- Hand-tight and wrench-tight configuration
- Custom packing available
- Available in bed volumes from 0.17 μ L to 2.6 μ L
- Low-volume, low-dispersion cartridges
- Auto-adjusting ZDV connection
- Intended for many repeat uses

EXP® TRAP COLUMN



The patented hand-tight EXP Trap Column is rated for use up to 20,000+ psi (1,400+ bar). This unique design connects directly to any injection valve (with 10-32 threads) or in-line with 1/16" stainless tubing for unparalleled convenience and efficiency.

The EXP Cartridge System enables chemists to quickly remove detergents or salts which can affect the ionization process in MS work. This trapping technique can concentrate the sample directly on-line and allows for increased recovery of precious sample material compared to off-line techniques. On-line trapping readily lends itself to automation for high-throughput analysis in UHPLC/MS applications. Free-Turn® architecture allows the user to change cartridges by hand without breaking fluid connections on the holder inlet/outlet.

EXP® Holders

15-02-03956	EXP Direct Connect Holder Includes fittings
15-02-03946	EXP In-Line Holder Includes fittings
15-02-04041	EXP All-In-One Holder Kit Includes In-Line + Direct Connect holder and components and fittings

EXP® TRAP CARTRIDGE SELECTION GUIDE

	Bed Volume	Load Rate (mL/min)	Dimensions	Dimension Code	Code	Phase	
3 PACKS	4µL	0.10 - 5	1 x 5mm	0 3 9 6 4	H P H Q H R H S H T H U H V	C18 C8 HILIC Phenyl-Hexyl PFP ES-CN Penta-HILIC	5µm HALO®
	10µL	0.20 - 8	1.5 x 5mm	0 3 9 6 9	H A H B H D H E H F H N	C18 C8 HILIC RP-Amide Phenyl-Hexyl Peptides ES-C18	2.7µm HALO®
	20µL	0.50 - 12	2.1 x 5mm	0 3 9 7 3	H G H H H I H J H K H L H M	C18 C8 C4 HILIC Phenyl-Hexyl SAX SCX	3µm EXP®
	40µL	1 - 15	3 x 5mm	0 3 9 7 8	E S	Custom	
	100µL	1 - 20	4.6 x 5mm	0 3 9 8 3			



To calculate the approximate sample capacity of each trap cartridge, we recommend using the ratio 4µg/1µL of bed volume. For more information about how to use this table, please see page 29.

EXP®

IN-LINE HOLDER**Advantages of the
EXP® Trap Column**

- Hand-tight to 20,000+ psi (1,400+ bar)
- Hand-tight trap replacement - no tools
- Uni-directional cartridge
- Custom packing available
- Available in bed volumes from 4µL to 100µL
- Hardened stainless steel end cap eliminates galling
- Auto-adjusting ZDV connections

EXP®

DIRECT CONNECT HOLDER

GUARD COLUMNS

The analytical column is the heart of any liquid chromatography system and remains the most problematic component. HPLC columns accumulate retained material which can dramatically reduce longevity and cause costly downtime resulting from premature column failure and troubleshooting.

Why Use A Guard Column?

The best way to protect an analytical column from fouling is to install a guard column between the injection valve and the analytical column. The guard column traps particulates, solvent impurities and retained sample components. The ideal guard column should have no effect on the separation. For best results a guard column with matching bonded phase and optimal hardware configuration should be selected.

Extra Column Volume

The evolving needs of HPLC applications such as smaller bed-volume columns, higher pressures and increased sensitivity create new demands on guard columns. Many guard column manufacturers overlook the dead volume that occurs when a guard column or holder is connected to the analytical column. The use of pre-swaged or one-piece nut and ferrule designs with fixed tube stems will increase extra column volume (shown in blue) and affect column efficiency. **(Figure 1)**

Other cartridge-style guard column systems require extra connections and tubing, adding to extra column volume and decreasing a system's overall performance. **(Figure 2)**

Figure 1

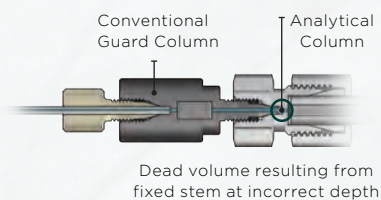
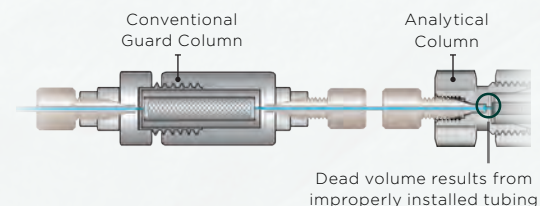
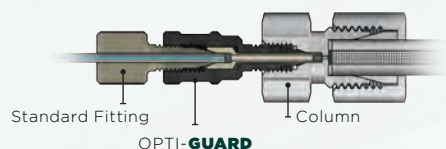

Figure 2



Floating tube stem provides ZDV connection into any port.





GUIDE TO OPTIMIZE GUARD COLUMNS

	OPTI-GUARD®	OPTI-LYNX™2	EXP®
	1mm Guard	Guard Column	Guard Column
	Pg. 41	*see below	Pg. 42
Maximum Pressure	 HIGH PRESSURE 6K PSI / 400 BAR	 HIGH PRESSURE 6K PSI / 400 BAR	 ULTRA HIGH PRESSURE 20K+ PSI / 1400+ BAR
Dimensions Available	1 x 14mm	2.1 x 5mm 3.0 x 5mm 4.6 x 5mm	1.0 x 5mm 1.5 x 5mm 2.1 x 5mm 3.0 x 5mm 4.6 x 5mm
Hand-Tight Holder/ Hand-Tight Cartridge Change	✓	✓	✓
Holder Fittings Included	✓	✓	✓
Auto Adjusting (ZDV) Port Connection	✓ Floating	✓ Spring-loaded	✓ Spring-loaded
Custom Packing Available	✓	✓	✓
Biocompatible Option	✓		
	<p>The OPTI-GUARD 1mm is an all-in-one solution. The mated holders and cartridges are disposable and designed for use with 1, 2.1, 3.0 and 4.6mm i.d. columns. The OPTI-GUARD is no larger than a standard HPLC Fitting.</p>	<p>OPTI-LYNX2 features a quarter-turn, quick-connect, hand-tight holder. The second generation OPTI-LYNX is more affordable and robust yet still allows users to change a cartridge in seconds.</p>	<p>Like the OPTI-LYNX system, the EXP Holder stays plumbed into the LC column. To change a cartridge, simply unscrew the holder cap by hand, replace the cartridge and screw the holder back together by hand. Easy, no tools needed.</p>

* Please contact Optimize for pressure rating and further product details.

OPTI-GUARD sets the standard for low impact, easy to use pre-column protection. Designed for use with ANY analytical (4.6, 3.0mm i.d.) and narrow-bore (2.1, 1.0mm i.d.) columns, the patented floating stem design automatically adjusts to all manufacturer's tube stop depths for a zero-dead-volume connection every time. The best part? It is no larger than a standard fitting.

Connecting the OPTI-GUARD requires no extra tubing or tools, while maintaining minimal impact. As always, custom packing is available.

OPTI-GUARD® 1mm Guard Column

10-02-00007	C18, 5/Pk
10-02-00010	C8, 5/Pk
10-02-03211	C4, 5/Pk
10-02-00014	Silica, 5/Pk
10-02-00018	Phenyl, 5/Pk
10-02-00022	Cyano/CN, 5/Pk
10-02-00026	Amino/NH2, 5/Pk
10-02-00030	Anion Exchange, 5/Pk
10-02-00034	Cation Exchange, 5/Pk
10-02-04068	DVB, 5/Pk
10-02-03463	Custom Packed, 5/Pk
10-02-01714	Method Development Kit (Assortment of your Choice 5/Pk)

OPTI-GUARD® 1mm Biocompatible Guard Column

10-02-03532	Biocompatible C18, 5/Pk
10-02-04708	Biocompatible C8, 5/Pk
10-02-03534	Biocompatible Silica, 5/Pk
10-02-03538	Biocompatible Cyano/CN, 5/Pk
10-02-03536	Biocompatible Amino/NH2, 5/Pk
10-02-03680	Biocompatible Anion Exchange, 5/Pk
10-02-03683	Biocompatible Cation Exchange, 5/Pk



The cartridge-based EXP Analytical Column system is designed for superior chromatographic analysis with each injection and is rated for routine use up to 20,000 psi.

The new EXP Analytical Column Holders incorporate Free-Turn® architecture allowing the user to quickly exchange columns without breaking any fluid connections. The EXP Analytical Column Holders are available in two formats: the standard In-Line format and Direct Connect, allowing the user to bypass additional tubing and connect directly to the detector for even greater resolution. Holder kits include EXP Nuts and Titanium Hybrid Ferrules to ensure repeated zero-dead-volume connections.

The new EXP Analytical Column Hardware is precision machined and held to the highest specifications to ensure excellent performance and repeatability. The column hardware is assembled up to the point of packing, allowing the customer to completely control the resins used, packing processes and testing conditions. Packing fixtures are also available and are compatible with all column dimensions.

EXP® Analytical Columns Advantages

- Hardware rated to 20,000+ psi (1400+ bar)
- Cartridge-based format
- Repeated column performance
- Free-Turn® architecture for quick exchanges of columns
- Quick connect/disconnect
- Repeated ZDV connections

EXP® Analytical Column Holders

15-70-04448	50mm In-Line Holder Kit
15-70-04450	100mm In-Line Holder Kit
15-70-04454	50mm Direct Connect Holder Kit
15-70-04455	100mm Direct Connect Holder Kit

EXP® Analytical Column Hardware Kits

15-70-04457	1.0mm x 50mm
15-70-04461	1.0mm x 100mm
15-70-04471	2.1mm x 50mm
15-70-04473	2.1mm x 100mm
15-70-04476	3.0mm x 50mm
15-70-04479	3.0mm x 100mm
15-70-04483	4.6mm x 50mm
15-70-04487	4.6mm x 100mm

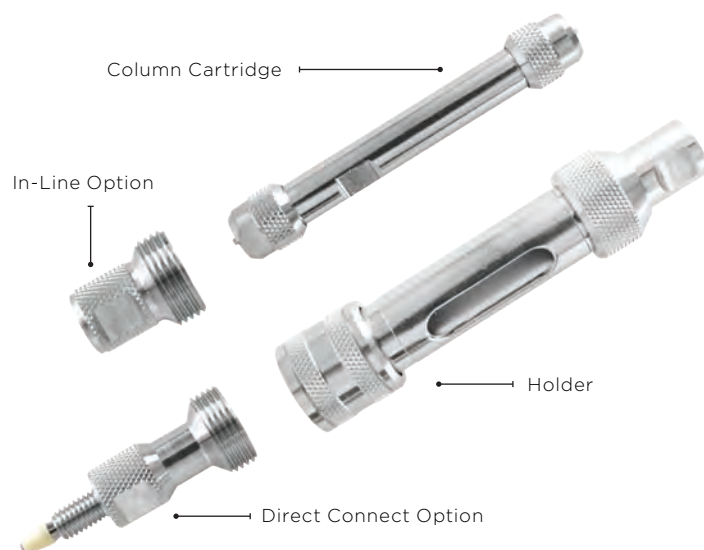

BACK PRESSURE REGULATORS

Optimize flow-through back pressure regulators utilize an active mechanism to maintain steady back pressure across a range of mobile phase viscosities and flow rates. Placing a back pressure regulator downstream from the detector will prevent solvent decompression and bubble formation in the flow cell, reducing baseline noise and drift.

Each regulator has an internal volume of 100 μ L and is available in pre-set pressures of 10, 30, 60, 100, or 150 psi.

PLACE A BACK PRESSURE REGULATOR
DOWNSTREAM FROM THE DETECTOR TO PREVENT SOLVENT
OUTGASSING AND BUBBLE FORMATION IN THE FLOW CELL,
REDUCING BASELINE NOISE AND DRIFT.

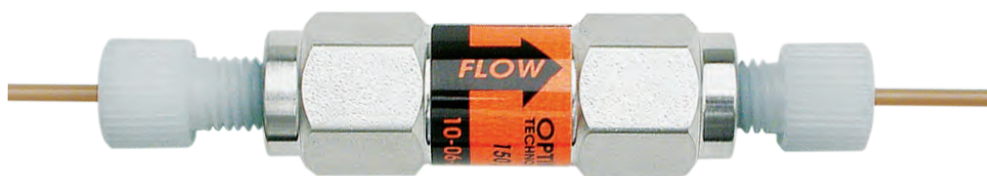

Back Pressure Regulators

10-06-00120	Back Pressure Regulator, 10 psi
10-06-00128	Back Pressure Regulator, 30 psi
10-06-00129	Back Pressure Regulator, 60 psi
10-06-00130	Back Pressure Regulator, 100 psi
10-06-00132	Back Pressure Regulator, 150 psi

All the above regulators include fittings



HPLC & UHPLC OEM SYSTEMS

In the following pages you will find replacement components designed specifically for OEM HPLC/UHPLC solvent delivery systems. At Optimize, all components are precision machined to the most exacting standards in the industry. All phases of the manufacturing process are controlled to ensure the highest quality. From the individual matching of check valve ball and seat sets to the proprietary blend of materials in our seals – experience Optimize quality.

EVERY REPLACEMENT COMPONENT WE OFFER IS DESIGNED TO MEET OR EXCEED ORIGINAL EQUIPMENT SPECIFICATIONS. GUARANTEED.

Optimize and OEM Components

Most instrument manufacturers will insist optimal instrument performance depends on exclusively using components that match their performance specifications. We could not agree more. Every Optimize replacement component is guaranteed to meet or exceed original equipment specifications. For example, several major OEM manufacturers incorporate Optimize components as original equipment on new HPLC and UHPLC instruments. Optimize OEM partners appreciate the positive impact Optimize products have on instrument performance.

Optimize Innovation

Innovation is our driving force. We offer a comprehensive selection of components for most brands of HPLC systems and are always developing new products to save customers time and money. Should you need a product that is not listed in this catalog, please call us to discuss your fluid handling needs.



HPLC FINDER™

	BRAND	MODELS	PAGE NO.
A	Agilent	1050, 1090, 1100, 1200, 1220, 1260	55-57
	Alcott	Micromeritics 760, 765	59
	Anspec	SM 909	59
B	Beckman/Altex	100A, 105, 110A/B, 110 Prep, 112/112M, 114/114M, 116, 118, 125, 126, 127, 128	58
	Bischoff	2200, 2250	59
D-G	Dionex	DQP, GPM-1&2, DRP, DXP, AGP, 2000, 4000, GP-40, IP-20, GP-50, IP-25	60
	ESA	Model 580, 582, 584, 5700 SDM	65-66
	Gilson	All Pumps with 5, 10 or 25mL S/SC Heads	69-70
H-J	Hewlett Packard	See Agilent	55-57
	Hitachi	655, L-6000, L-6200/6200A, L-7100/LaChrom, L-2100, Smash Pump, L-2130, 7200, 7250	61
	Jasco	BIP-1, 880/980 Series, PU-2080, 2085, 2089, 1580-C02, 980, 1586, 2086, 986	62
L-P	LDC/Milton Roy	All Analytical Pumps (including Constametric, Minimetric, Minipump, Mini Duplex)	67
	LKB/Amersham/ Pharmacia	2150, 2248, 2500	63
	PerkinElmer	Series 1, 2, 3, 3B, 4, 10, 100, Model 250, 200, 400, 410, 620, Integral 4000	64
R-S	Rainin	HP, HPX, HPXL, SD 200/300, ProStar 210/215	69-70
	Shimadzu	LC-30, LC-30ADSF, i-Series, LC-20ABXR, LC-20ADXR, LC-10AD, LC-10ADVP, LC-10AT, LC-10ATVP, LC-20AB, LC-20AT, LC-20AD, LC-20AP, LC-6A, LC-7A, LC-8A, LC-9A, LC-10AS, LC-600, LC-2010, GP-20 & 50, SIL-10ADUP, GEP	65-66
	Spectra-Physics	8700, 8800, 8810, IsoChrom, P-Series, 8700XR, 8750	68
T-W	Thermo	See LDC/Milton Roy, Spectra-Physics for model listings	67-68
	Varian	2010, 2510, 9000 Star/9000 Series, ProStar 210/215, 220, 230, 240	69-70
	Waters	6K/6KA, Alliance, 2690, 2695, 2790, 2795, M45/45G, M501, 510, 515, 590, 600/600E, 610, 616, 625/626, 650, 6000, 6000A, DeltaPrep 3000 (#4 and #6 Heads), 1525, 1515, LC Module 1, GPC/V200	71-73



A properly functioning check valve is virtually unnoticeable. An improperly functioning check valve can lead to a noisy baseline, pressure fluctuations and inconsistent flow. A check valve can have a large impact on the performance of your pump. It is imperative when choosing replacement check valves to select the very best. The OPTI-MAX Check Valve System is the very best. Discover the new innovations in the OPTI-MAX Check Valve line.

CHECK VALVES ARE A CRUCIAL, YET OFTEN OVERLOOKED COMPONENT OF THE HPLC SYSTEM.

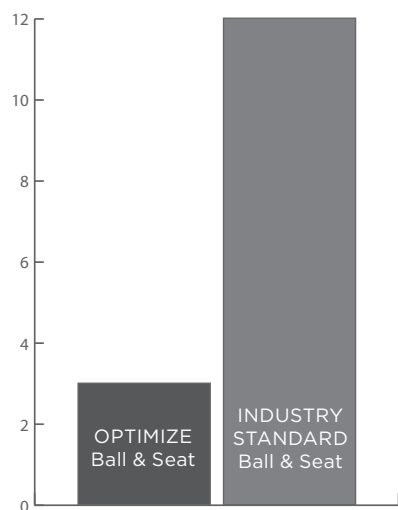

Bubbles of nitrogen/
minute at 90 psi
which leak from
ball & seat.

A BETTER CHECK VALVE

Tighter specifications make a better valve. A check valve can only function effectively if it activates and seals properly in response to the piston cycle. The seating process is fairly simple. The ball lands on the seat and creates a seal. However, there are many factors that contribute to optimal seating. Optimize check valves are designed and engineered to be the most responsive in the industry.

Each ball and seat set is individually matched to ensure a lock-and-key fit. This guarantees 3 bubbles/minute or less in the industry standard nitrogen bubble test. Common acceptable standards are 12 bubbles or less. Optimize check valves minimize the ball travel distance within the check valve. Less travel distance equals quicker seating and more accurate pump metering.

OPTI-MAX®

A UNIVERSAL SOLUTION

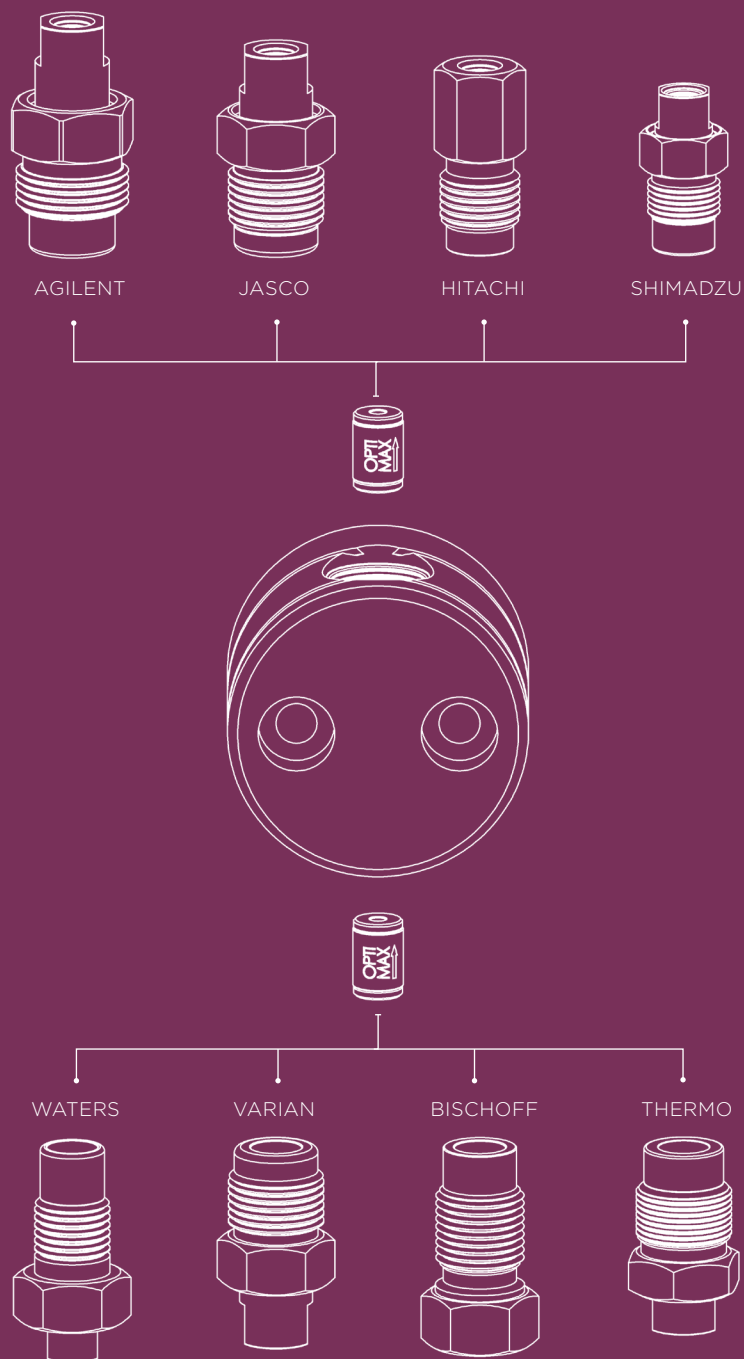

A single OPTI-MAX cartridge is interchangeable across multiple pump brands and can function in either the inlet or outlet position.

The same OPTI-MAX cartridge fits into OPTI-MAX housings for pumps manufactured by Waters, Shimadzu, Agilent/HP, and many other OEM solvent delivery systems.

The modular cartridge system allows you to minimize the number of spare check valve cartridges you keep on hand and dramatically reduce the cost of inventory required to cover maintenance needs.

OPTI-MAX® FREE-TURN® HOUSING

Optimize was the first in the industry to introduce the concept of the OPTI-MAX Free-Turn® housing. The thread tightens a check valve housing into the pump head and spins independently from the inner housing body. The check valve can then be changed without disconnecting any tubing. An idea born in efficiency.

Most OPTI-MAX Check Valve housings feature the Free-Turn design. To see if housings are available for your system, look for the Free-Turn logo .

OPTI-MAX® FREE-TURN® HOUSINGS
CAN BE REMOVED WITH THE TUBING STILL ATTACHED,
ACCELERATING CHECK VALVE MAINTENANCE WHILE
REDUCING FITTING WEAR.

FREE-TURN® IN ACTION



Place wrench on the hex nut and turn. The hex nut or thread ring will turn independently of the fitting connection.

Continue to unscrew the thread ring until the entire check valve assembly is removed from the pump head.

Discard old check valve cartridge & replace with new cartridge.

Install entire assembly into pump head.

OPTI-MAX cartridges are available in several different sizes and combinations of body and ball/seat materials. All cartridges are manufactured and leak tested to meet the highest performance standards.

OUR RECOMMENDATION: STAINLESS/CERAMIC

For high mechanical strength, stainless steel cartridges are the best choice. Ceramic ball & seat sets have a higher density, which can make the valve more responsive and help the ball seat faster in lighter solvents.

For biocompatible HPLC systems with nonmetallic flow paths or high percentages of THF, use PEEK cartridges with ceramic balls & seats.

The cartridge body materials listed above are also available with ruby and sapphire ball & seat combinations.

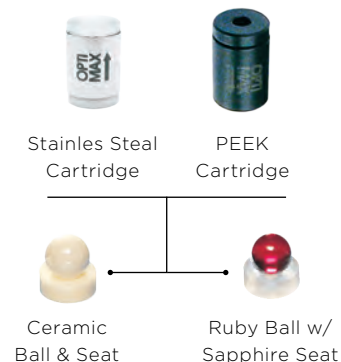

CARTRIDGE MATERIAL OPTIONS | 2 PACKS



1/32"	10-39-02004	Cartridge fits in all housings using 1/16" and 1/8" cartridge. Only available in PEEK/PPS body with ruby/ sapphire ball & seat.
1/16"	10-46-02004	Recommended: Microbore stainless steel cartridge with ceramic ball & seat
	10-48-02004	Microbore PEEK cartridge with ceramic ball & seat
	10-47-02004	Microbore stainless steel cartridge with ruby ball & sapphire seat
	10-49-02004	Microbore PEEK cartridge with ruby ball & sapphire seat
1/8"	10-56-02004	Recommended: Standard stainless steel cartridge with ceramic ball & seat
	10-58-02004	Standard PEEK cartridge with ceramic ball & seat
	10-57-02004	Standard stainless steel cartridge with ruby ball & sapphire seat
	10-59-02004	Standard PEEK cartridge with ruby ball & sapphire seat
3/16"	10-66-02005	Recommended: stainless steel cartridge with ceramic ball & seat
	10-68-02005	PEEK cartridge with ceramic ball & seat
	10-67-02005	Stainless steel cartridge with ruby ball & sapphire seat
	10-69-02005	PEEK cartridge with ruby ball & sapphire seat
1/16"	10-76-02004	OPTI-MAX EXP stainless steel cartridge with ceramic ball & seat
	10-77-02004	OPTI-MAX EXP stainless steel cartridge with ruby ball & sapphire seat
	10-86-02004	OPTI-MAX EXP stainless steel cartridge with double ceramic balls & seats



We cannot guarantee the OPTI-MAX check valve cartridge will fit in OEM housings. OPTI-MAX cartridges must be used with OPTI-MAX housing for optimal results.

SEALS & PISTONS

By design, seals and pistons are a consumable part of an HPLC pump and should be replaced on a regular preventative maintenance schedule. To maintain peak performance and avoid unplanned downtime, piston seals should be replaced every three to six months while sapphire pistons require inspection every six months with yearly or as-needed replacement.

SEALS

Optimize piston seals are the longest lasting seals on the market. Machined from either of two proprietary polymer blends, UHMW-PE or ITB, Optimize seals provide ultimate high pressure sealing capacity. For mostly aqueous buffered mobile phases, OPTI-SEAL UHMW-polyethylene is the preferred choice. Specially designed to be more resistant to abrasion and wear than standard polyethylene seals, the seals can last up to seven times longer under mostly aqueous conditions. Despite the UHMW-PE's durability, the material has a coefficient of friction approaching that of PTFE. The homogenous polymer nature leads to less shedding. When it does occur, a larger, more fibrous particle is produced and is easily caught by a filter frit.



PTFE-based Improved Blend (ITB) seals are a superior choice for applications with elevated temperatures, high organic content, or when the broadest possible solvent compatibility is required. ITB seals tend to be softer than those made from UHMW-PE, making the seals more forgiving at high pressures where piston side-loading or misalignment may occur. This softer nature also leads to more shedding. However, the ITB proprietary blend is designed to shed particles that are large enough to be caught at the surface of a standard 2µm frit and not embed within the frit.

PISTONS

Optimize sapphire pistons offer optimal concentricity and resistance to wear. Each sapphire rod is specifically cut in relation to the grain of the crystal lattice, yielding maximum resistance to breakage with superior wear characteristics. Attachment of the rod to the piston ferrule is performed through a proprietary process ensuring concentricity. This is an important and often overlooked procedure that has a direct effect on seal lifetime.



SEAL FORM TOOL KIT

Installing a piston seal can be a tricky undertaking. A relatively small seal must fit into the seal cavity in such a way to ensure the seal is inserted evenly without distortion or damage. The Optimize Seal Forming/Insertion Tool Kit is specifically designed for easy and successful installation.

The kit contains three tools to accommodate all HPLC piston seals. One end has a beveled cavity for seal forming while the other end is an insertion support for perfect seal installation. Each kit contains instructions for maximizing seal life and a solvent Compatibility Guide to aid in seal material selection.

THE KIT INCLUDES THREE SIZES ASSURING THE PERFECT SEAL FIT EVERY TIME



Forming cavities are available in three different sizes allowing the user to choose the best tool for seal installation.

The piston seal is formed by pressing the tool onto the seal jacket.

The seal is then pressed into the pump head seal cavity using the insertion support.

Seal Forming/Insertion Tools

10-10-02695	Seal Forming/Insertion Tool Kit Includes Three Forming/Insertion Tools (Small, Medium, Large), Instruction Booklet & Solvent Compatibility Guide
10-10-02699	Small Seal Forming/Insertion Tool
10-10-02700	Medium Seal Forming/Insertion Tool
10-10-02701	Large Seal Forming/Insertion Tool



TIP: For best performance, always use methanol or isopropanol to presoak piston seals for five to ten minutes prior to installation. Wet all mating surfaces (seal, piston, seal cavity) as the seal is formed and installed.

OPTI-MAX[®] CONVERSION KITS

Dionex
25-58-01242



Hitachi
28-46-02148



LDC
31-56-02153

OPTI-MAX Conversion Kits contain all the check valves necessary for your HPLC pump. Kits are grouped under single part numbers and priced up to 20% off list.

Each kit includes all the OPTI-MAX check valve housings and cartridges needed to convert an HPLC instrument. Simply find your HPLC pump/brand model in the list below and use the conversion kit part number. Each kit includes our recommended stainless steel/ceramic OPTI-MAX cartridges. Please note, OPTI-MAX PEEK cartridges are supplied for listed biocompatible systems. It is also possible to substitute an alternate cartridge material at the same kit price.

BRAND	PUMP MODEL	KIT PART #	INLETS	OUTLETS
Agilent/HP	1090 Systems	27-38-01959	1	1
	1050/1100/1200/1220/1260	27-56-01330	0	1
Beckman	100A, 126,	22-66-02137	2	2
	110A/B, 112/112M, 114/114M, 116	22-66-02138	1	1
Bischoff	2200 Microbore	24-46-02141	1	1
	2200, SM909, 760	24-56-02140	1	1
Dionex	DXP, GP-50/IP-25 DQP,	25-58-02143	1	1
	GPM-1, GPM-2, DRP,		1	1
	AGP, 2000, 4000		1	1
Gilson/Rainin	5, 10 & 25mL Head	26-56-02144	1	1
Hitachi	L-7100, L-2130	28-46-02148	1	1
Jasco	BIP-1	42-56-02150	2	2
	880, 980	42-56-02151	1	1

OPTI-MAX[®] CONVERSION KITS

BRAND	PUMP MODEL	KIT PART #	INLETS	OUTLETS
LDC/Milton Roy	Minipump, Minimetric	31-56-02152	1	1
	Constametric, Mini Duplex	31-56-02153	2	2
LKB/Amersham/ Pharmacia	2150, 2248, 2500	32-46-02154	2	2
PerkinElmer	4, 200, 250, 400, 410, 620, 4000	33-56-02157	2	1
Shimadzu	LC-10A, 9A, 600	34-46-02158	2	2
	LC-AT, ATPV	34-46-02160	1	1
	LC-20AB, AD, AT, LC-10ADVP, 2010, GPC-20 & 50 (100µL Head), ESA 582 & 584	34-46-02627	2	2
	LC-10AS, 6A	34-56-02159	1	1
	LC-20AP, 8A	34-66-02114	2	2
	LC-20ABXR	34-86-04139	2	2
	LC-30ADSF, i-Series, LC-20ABXR/ ADXR	34-86-05140	2	2
Spectra-Physics	8700, 8800, 8810	35-56-02161	1	1
	IsoChrom, P-Series	35-56-02162	1	1
Thermo	Surveyor L-Pump	50-46-03645	1	1
Varian	9000 Star, 9010, 9012 ProStar 220, 230, 240	38-56-01704	0	1
	2010	38-56-02164	2	2
	2510	38-56-02165	1	1
Waters	616	39-46-02168	2	2
	625/626	39-48-02170	2	2
	Alliance 2690, 2695, 2790, 2795	39-46-02187	2	0
	100µL/Dual Head Systems	39-56-02166	2	2
	100µL/Single Head Systems	39-56-02186	1	1
	Extended Flow Systems	39-66-01712	1	1
	225µL/Head	39-66-02167	2	2
	400µL & 900µL/Head	39-66-02169	0	2



PerkinElmer
33-56-02157



Shimadzu
34-46-02158



Waters
39-46-02187



Waters
39-48-02170

AGILENT / HEWLETT PACKARD

Optimize has developed the new OPTI-MAX 600 bar Active Inlet replacement cartridge (AIV). The AIV is comparable in price to the 400 bar active inlet cartridge offered by Agilent.

The OPTI-MAX 600 bar AIV utilizes the proprietary OPTI-MAX technology with wetted materials of 316 SS, PEEK and zirconia (ceramic) for complete compatibility and reliability in both 400 bar and 600 bar applications. The OPTI-MAX Zirconia ball/seat sets are the best in the industry and are individually tested to perform at 3 bubbles or less in the industry-standard 90 psi nitrogen leak test. The OPTI-MAX AIV withstands well over 20,000 psi as an assembled cartridge. Ball travel is minimized allowing the cartridge to exhibit extremely low pulsation in both 600 bar and 400 bar applications. The rugged 316 stainless steel OPTI-MAX AIV cartridge body is easily inserted and tightened for the higher pressure application of 600 bar instruments. The cartridge is completely compatible with both 600 and 400 bar instruments.

By choosing the OPTI-MAX 600 bar AIV cartridge, laboratories with multiple Agilent 400 bar and 600 bar instruments need only purchase and inventory one OPTI-MAX AIV cartridge. Maintenance and repair become much simpler and less costly.

** Not compatible with valve body 0491-0131 **

OPTI-MAX® 600 BAR AIV CHECK VALVE CARTRIDGE FOR AGILENT SYSTEMS

Part #	OEM#
27-38-04713	G1312-60020, 5062-8562



Compatible Pumps

Agilent 1100 Quaternary Pump (G1311A)
 Agilent 1100 Binary Pump (G1312A)
 Agilent 1100 Capillary Pump (G1376A)
 Agilent 1200 Isocratic Pump (G1310A)
 Agilent 1200 Binary Pump (G1312C)
 Agilent 1260 Infinity Binary Pump (G1312B)
 Agilent 1260 Infinity Isocratic Pump (G1310B)
 Agilent 1260 Infinity Quaternary Pump (G1311B)
 Agilent 1260 Infinity Quaternary Pump VL (G1311C)

Key Features

- Wetted materials: 316 SS, PEEK and zirconia (ceramic)
- Compatible with both 400 bar and 600 bar applications
- Rated to 20,000+ psi
- OPTI-MAX Zirconia (ceramic) ball/seat set individually tested
- Reduces inventory
- Comparable in price to the standard 400 bar Agilent replacement cartridge

OPTI-MAX® CHECK VALVES

Agilent/HP 1050, 1100, 1200, 1220, 1260		OEM #
27-56-01330	OPTI-MAX Outlet Housing & Cartridge	G1311-60012, G1312-60012
10-56-02004	OPTI-MAX Replacement Cartridges, 1/8" Ball, 2/Pk	
27-38-04713	OPTI-MAX 600 bar AIV Replacement Cartridge	G1312-60020, 5062-8562
27-46-05033	OPTI-MAX Passive Inlet Housing & Cartridge ** for Agilent 1220 and 1260 only **	G1312-60066
10-46-02004	OPTI-MAX Replacement Cartridges, 1/16" Ball, 2/Pk	

OPTIONS: Stainless steel/ceramic OPTI-MAX Cartridges are listed above.
For other options, please see page 50.

Agilent/HP 1090		OEM #
27-38-00680	Inlet Housing & Cartridge	79835-25211
27-38-00682	Outlet Housing & Cartridge	79835-25211
27-38-00672	Replacement Cartridges, 2/Pk	79835-67101

SEALS, PISTONS & OTHER PARTS

Agilent/HP 1050, 1100		OEM #
27-36-01570	OPTI-SEAL UHMW-PE* Piston Seal	0905-1420
27-36-01571	OPTI-SEAL UHMW-PE* Piston Seal, 10/Pk	
27-36-01572	ITB PTFE** Piston Seal	5063-6589
27-36-01573	ITB PTFE** Piston Seal, 10/Pk	
27-36-03073	PTFE*** Pump Seal, Green, Premium Grade	
27-36-03074	PTFE*** Pump Seal, Green, Premium Grade, 10/Pk	
27-36-02364	OPTI-SEAL UHMW-PE* Wash Seal	0905-1175
27-36-02365	OPTI-SEAL UHMW-PE* Wash Seal, 10/Pk	
27-36-02366	ITB PTFE** Wash Seal	0905-1175
27-36-02367	ITB PTFE** Wash Seal, 10/Pk	
27-36-02851	Gasket Wash Seal, 6/Pk	5062-2484
27-04-02852	PTFE Frits, 5/Pk	01018-22707
27-31-02853	2-in-1 Seal Cap (Replaces OEM Gold Seal - see next page for details)	5067-4728, 5062-2485
27-34-00658	Sapphire Piston	5063-6586

*UHMW-PE - Ultra High Molecular Weight Polyethylene

**ITB PTFE - Improved PTFE Blend

***Premium grade PTFE for maximum chemical compatibility and wear resistance



OPTI-MAX for Agilent



AIV Replacement Cartridge

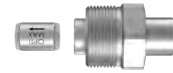

Agilent Passive inlet



Agilent/HP 1090, Outlet Housing & Cartridge



27-36-01570



27-36-02364



27-36-02366



27-36-01572



27-34-00658

AGILENT / HEWLETT-PACKARD



2-in-1 Seal Cap on Agilent

2-IN-1 SEAL CAP FOR 1050/1100/1200

The 2-in-1 Seal Cap replaces both the OEM outlet gold seal and outlet cap with a single component. Use it on purge valves, OEM outlet check valves or anywhere on 1050/1100/1200 systems where gold seals and outlet caps are required.

Agilent/HP 1050, 1100, 1200**27-31-02853**

2-in-1 Seal Cap

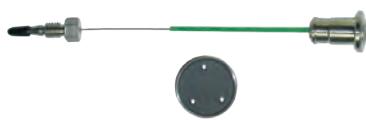
OEM #5062-2485,
5001-3707,
5067-4728Autosampler
Replacement Parts

AUTOSAMPLER REPLACEMENT PARTS

Agilent/HP 1100, 1200**27-31-03212**

Rotor Seal Assembly

OEM #

0100-1853

27-31-03329

Needle Seat Assembly

G1313-87101

Agilent/HP 1050**27-31-03603**

Rotor Seal

OEM #

0101-0626

Agilent/HP 1090**27-31-03649**

Rotor Seal, 3 Grooves, Polyimide

OEM #

7010-039

27-31-03670

Rotor Seal, 2 Grooves, Polyimide

0101-0623

Rotor Seal
27-31-03603

LAMPS

Agilent/HP**27-32-02844**Deuterium Lamp, 1050C,
1050DAD, 1090, 1040**OEM #**

79883-60002

27-32-02845DoubleLife Deuterium Lamp,
1100, 1200 DAD5181-1530,
2140-0813**27-32-02846**DoubleLife Deuterium Lamp,
1100, 1200 VWD

G1314-60100

27-32-02715Deuterium Lamp,
1100 VWD G1314A

G1314-60100

27-32-04038

Doublelife Deuterium Lamp, 1050

79883-60002

Agilent 1100 DAD
27-32-02845

OPTI-MAX® CHECK VALVES

**100A, 110A/B, 112/112M, 114/114M,
116, 118, 125, 126, 127, 128** 

		OEM #
22-66-00516	OPTI-MAX Inlet Housing & Cartridge	240720
22-66-00520	OPTI-MAX Outlet Housing & Cartridge	240721
10-66-02005	OPTI-MAX Replacement Cartridges, 3/16" Ball, 2/Pk	

OPTIONS: Stainless steel/ceramic OPTI-MAX Cartridges are listed above.
For other options, please see page 50.

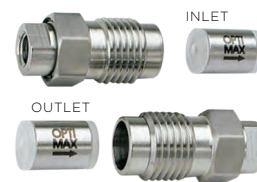

OPTI-MAX for Beckman/Altex

BISCHOFF

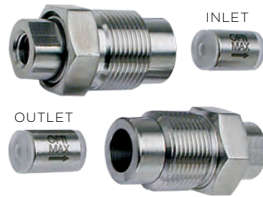
OPTI-MAX
For Bischoff

24-34-00559



24-36-00573



24-36-00574

OPTI-MAX® CHECK VALVES

**Bischoff 2200, 2250, Anspec SM909, Alcott
Micromeritics 760, 765 (Analytical Versions)**

		OEM #
24-56-00576	OPTI-MAX Inlet Housing & Cartridge	2200-0220, 760/25602/00
24-56-00581	OPTI-MAX Outlet Housing & Cartridge	2200-0230, 760/25604/00
10-56-02004	OPTI-MAX Replacement Cartridges, 1/8" Ball, 2/Pk	

**Bischoff 2200, Anspec SM909, Alcott
Micromeritics 760 (Microbore Versions), 765**

		OEM #
24-46-00585	OPTI-MAX Inlet Housing & Cartridge	2200-0120, 760/25602/01
24-46-00589	OPTI-MAX Outlet Housing & Cartridge	2200-0130, 760/25604/01
10-46-02004	OPTI-MAX Replacement Cartridges, 1/16" Ball, 2/Pk	

OPTIONS: Stainless steel/ceramic OPTI-MAX Cartridges are listed above.
For other options, please see page 50.

SEALS & PISTONS

**Bischoff 2200, Anspec SM909,
Alcott Micromeritics 760, 765 (Analytical Versions)**

		OEM #
24-34-00559	Sapphire Piston	2200-0210, 760/25803/00

**Bischoff 2200, Anspec SM909,
Alcott Micromeritics 760 (Microbore Versions), 765**

		OEM #
24-36-00573	ITB PTFE** Piston Seal	2200-0112, 760/25601/01
24-36-00575	ITB PTFE** Piston Seal, 10/Pk	
24-36-00574	Piston Seal Support Ring	2200-0111, 760/25603/01

**ITB PTFE - Improved PTFE Blend

OPTI-MAX® CHECK VALVES

GP-40*/IP-20*, DQP, GPM-1, DRP, GPM-2, DXP, AGP (Analytical), 2000, 4000, GP-50/IP-25

		OEM #
25-58-00613	OPTI-MAX Inlet Housing & Cartridge	047660, 38273
25-58-00612	OPTI-MAX Outlet Housing & Cartridge	047661, 42761
10-58-02004	OPTI-MAX Replacement Cartridges, 1/8" Ball, 2/Pk	

OPTIONS: PEEK/ceramic OPTI-MAX Cartridges are listed above. For other options, please see page 50.

*The OPTI-MAX Check Valves above fit GP-40/IP-20 pumps. Users of microbore versions of these pumps should order OPTI-MAX microbore (1/16") cartridges. Please see page 50.

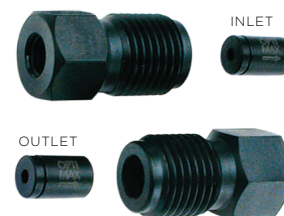

OPTI-MAX for Dionex

PISTONS & SEALS

GP-40/IP-20 (Analytical), DQP, GPM-1, DRP, GPM-2, DXP, AGP (Analytical), 2000, 4000

		OEM #
25-36-00597	OPTI-SEAL UHMW-PE* Piston Seal (Hastelloy C® Spring)	40859
25-36-00598	OPTI-SEAL UHMW-PE* Piston Seal (Hastelloy C® Spring), 10/Pk	
25-36-00599	UHMW-PE* Piston Seal, (Elastomer O-Ring)	35686
25-36-00600	UHMW-PE* Piston Seal, (Elastomer O-Ring), 10/Pk	
25-36-00601	Back-Up Seal, for all models except GP40/IP20	36901
25-36-00602	Back-Up Seal, for all models except GP40/IP20, 10/Pk	

*UHMW-PE - Ultra High Molecular Weight Polyethylene



25-36-00597



25-36-00599



25-36-00601

LAMPS

Dionex		OEM #
25-32-02081	Deuterium Lamp, Dionex VDM-1, DSA-1	
25-32-02820	Deuterium Lamp, Dionex CES 1, VDM-2	40651

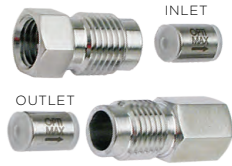

Dionex
25-32-02081

OPTI-MAX for
L-7100

28-36-00690



28-36-00691

HITACHI

OPTI-MAX® CHECK VALVES

L-7100 (LaChrom), L-2130

28-46-02092 OPTI-MAX Inlet Housing & Cartridge

OEM

ANO-0836, 810-1004,
809-1408

28-46-02094 OPTI-MAX Outlet Housing & Cartridge

ANO-0837, 810-1005,
809-1409

10-46-02004 OPTI-MAX Replacement Cartridges,
1/16" Ball, 2/Pk

OPTIONS: Stainless steel/ceramic OPTI-MAX cartridges are listed above.
For other options, please see page 45.

L-2100, Smash Pump, L-2130

28-39-02092 OPTI-MAX Inlet Housing & Cartridge

28-39-02094 OPTI-MAX Outlet Housing & Cartridge

10-39-02004 OPTI-MAX Check Valve Cartridge Replacement,
Microbore 1/32", 2/Pk

SEALS

655, L-6000, L-6200/L-6200A, L-7100 (LaChrom), L-2100, Smash Pump

28-36-00690 OPTI-SEAL UHMW-PE* Piston Seal

OEM

655-1080

28-36-00692 OPTI-SEAL UHMW-PE* Piston Seal, 10/Pk

28-36-00691 OPTI-SEAL UHMW-PE*
Piston Seal (Hastelloy C® Spring)

28-36-00693 OPTI-SEAL UHMW-PE*
Piston Seal (Hastelloy C® Spring), 10/Pk

*UHMW-PE - Ultra High Molecular Weight Polyethylene

OPTI-MAX® CHECK VALVES

BIP 1

		OEM #
42-56-01038	OPTI-MAX Inlet Housing & Cartridge	6260-H101A
42-56-01043	OPTI-MAX Outlet Housing & Cartridge	6260-H102A
10-56-02004	OPTI-MAX Replacement Cartridges, 1/8" Ball, 2/Pk	

880/980 Series

		OEM #
42-56-01544	OPTI-MAX Inlet Housing & Cartridge	6560-H405A
42-56-01546	OPTI-MAX Outlet Housing & Cartridge	6560-H404A
10-56-02004	OPTI-MAX Replacement Cartridges, 1/8" Ball, 2/Pk	

OPTIONS: Stainless steel/ceramic OPTI-MAX cartridges are listed above.
For other options, please see page 50.

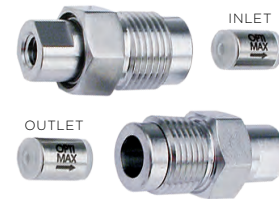

OPTI-MAX for BIP 1



OPTI-MAX
for 880/980 Series

SEALS & PISTONS

BIP-1, PU-2080, 2085, 2089, 1580-C02, 980, 880, 1586, 2086, 986

		OEM #
42-36-01357	OPTI-SEAL UHMW-PE* Piston Seal	6560-H148, H149A
42-36-01358	OPTI-SEAL UHMW-PE* Piston Seal, 10/Pk	
42-36-01355	ITB PTFE** Piston Seal	6560-H148-PE, H149A
42-36-01356	ITB PTFE** Piston Seal, 10/Pk	
42-34-01354	Sapphire Piston	2305-0005A

*UHMW-PE - Ultra High Molecular Weight Polyethylene

**ITB PTFE - Improved PTFE Blend



42-36-01357



42-36-01355

LAMPS

Jasco

		OEM #
42-32-02841	DoubleLife Deuterium Lamp, 870, 875	5330-0097
42-32-02842	DoubleLife Deuterium Lamp, UV-1570, -1575, -2070, -2075, 975 B/C Series	5330-0091



42-34-01354



42-32-02842

LKB / AMERSHAM / PHARMACIA



OPTI-MAX® CHECK VALVES

LKB 2150, 2248, 2500 

		OEM #
32-46-00782	OPTI-MAX Inlet Housing & Cartridge	80-1035-19
32-46-00787	OPTI-MAX Outlet Housing & Cartridge	2150-300
10-46-02004	OPTI-MAX Replacement Cartridges, 1/16" Ball, 2/Pk	

OPTIONS: Stainless steel/ceramic OPTI-MAX cartridges are listed above.
For other options, please see page 50.



SEALS & PISTONS

LKB 2150, 2248, 2500

		OEM #
32-36-01303	ITB PTFE** Piston Seal, with Back-Up Ring	80-1037-39
32-36-01304	ITB PTFE** Piston Seal, with Back-Up Rings, 10/Pk	
32-34-00771	Sapphire Piston, 2150	80-1035-52

**ITB PTFE - Improved PTFE Blend



LAMPS

LKB/Amersham/Pharmacia

32-32-02821	Deuterium Lamp, LKB Ultraspec I, II, III, Plus, 4050, 4051, 4054, 2141, 2151
--------------------	---

OPTI-MAX® CHECK VALVES

Series 4, Model 250, 200*, 400, 410, 620, Integral 4000*

		OEM #
33-56-00830	OPTI-MAX Inlet Housing & Cartridge	0254-0177
33-56-00835	OPTI-MAX Outlet Housing & Cartridge	0254-0197
10-56-02004	OPTI-MAX Replacement Cartridges, 1/8" Ball, 2/Pk	

OPTIONS: Stainless steel/ceramic OPTI-MAX Cartridges are listed above. For other options, please see page 50.

*These pumps have an intermediate check valve which is identical to the inlet check valve. To order a replacement intermediate valve, use the OPTI-MAX inlet part number.

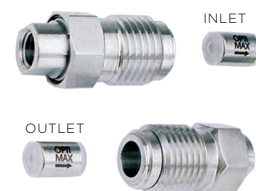

Model 250, Series 4, 200, 400, 410, 620, Integral 4000

SEALS & PISTONS

		OEM #
Model 200, 250, 410, 620, Integral 4000 (Mfd. After 12/89)		
33-34-00798	Piston (High Pressure)	N260-0124



33-34-00798

		OEM #
Series 1, 2, 3, 3B, 10, 200, Model 250, 400, 410, 620, Integral 4000,		
33-36-01301	OPTI-SEAL UHMW-PE* Piston Seal (High Pressure)	0990-7324
33-36-01302	OPTI-SEAL UHMW-PE* Piston Seal (High Pressure), 10/Pk	



33-36-01301

		OEM #
Series 4, Model 400, 410, 620, Integral 4000		
33-36-00804	OPTI-SEAL UHMW-PE* Piston Seal (Low Pressure)	0990-7330
33-36-00805	OPTI-SEAL UHMW-PE* Piston Seal (Low Pressure), 10/Pk	



33-36-00804

		OEM #
Series 100		
33-36-00806	OPTI-SEAL UHMW-PE* Piston Seal	N260-0108
33-36-00807	OPTI-SEAL UHMW-PE* Piston Seal , 10/Pk	
33-36-00808	ITB PTFE** Piston Seal	N260-0109
33-36-00809	ITB PTFE** Piston Seal, 10/Pk	



33-36-00806

*UHMW-PE - Ultra High Molecular Weight Polyethylene

**ITB PTFE - Improved PTFE Blend



33-36-00808

LAMPS

		OEM #
PerkinElmer		
33-32-03117	Deuterium Lamp, 200 UV/Vis	N292-0149
33-32-03114	DoubleLife Deuterium Lamp, Series 200 DAD	N292-2046



33-32-03114

SHIMADZU

OPTI-MAX® CHECK VALVES

**LC-30**

		Shimadzu #:
34-76-05135	OPTI-MAX Inlet Housing & Cartridge	228-52964-95
10-76-02004	OPTI-MAX Replacement Cartridges (for Inlet), 1/16" Ball, 2/Pk	
34-86-05139	OPTI-MAX Inlet Housing & Cartridge	228-53334-96
10-86-02004	OPTI-MAX Replacement Cartridges (for Outlet), 1/16" Double Ball, 2/Pk	

**LC-30ADSF, i-Series, LC-20ABXR, ADXR**

		Shimadzu #
34-86-02644	OPTI-MAX Inlet Housing & Cartridge	228-48249-91 228-48249-96
34-86-00893	OPTI-MAX Outlet Housing & Cartridge	228-45705-91
10-86-02004	OPTI-MAX Replacement Cartridges 1/16" Ball, 2/Pk	



LC-10AT, LC-10ATVP

LC-10AT, ATVP

		Shimadzu #
34-46-01983	OPTI-MAX Inlet Housing & Cartridge	228-32166-91
34-46-00893	OPTI-MAX Outlet Housing & Cartridge	228-39093-92 228-32531-92 228-34976-91
10-46-02004	OPTI-MAX Replacement Cartridges, 1/16" Ball, 2/Pk	



LC-10ADVP

LC-20AB, AD, AT, LC-10ADVP, 2010, GPC-20 & 50 (100µL Head), ESA 582 & 584

		ESA#	Shimadzu #
34-46-02644	OPTI-MAX Inlet Housing & Cartridge	70-4056	228-39093-92 228-45704-91
34-46-00893	OPTI-MAX Outlet Housing & Cartridge	70-4057	228-34976-91 228-45705-91 228-37147-93
10-46-02004	OPTI-MAX Replacement Cartridges, 1/16" Ball, 2/Pk		



LC-10AD, LC-600, LC-9A

LC-10AD, 9A, 600 (also ESA Model 580)

		ESA#	Shimadzu #
34-46-00885	OPTI-MAX Inlet Housing & Cartridge	70-0734	228-18522-91 228-33492-91
34-46-00893	OPTI-MAX Outlet Housing & Cartridge	70-0735	228-18522-92 228-32531-92
10-46-02004	OPTI-MAX Replacement Cartridges, 1/16" Ball, 2/Pk		



LC-10AS, LC-6A

LC-10AS, 6A

		Shimadzu #
34-56-00902	OPTI-MAX Inlet Housing & Cartridge	228-12353-91
34-56-00907	OPTI-MAX Outlet Housing & Cartridge	228-09054-93
10-56-02004	OPTI-MAX Replacement Cartridges, 1/8" Ball, 2/Pk	



LC-8A

LC-20AP, 8A

		Shimadzu #
34-66-02112	OPTI-MAX Inlet Housing & Cartridge	228-20256-91
10-66-02005	OPTI-MAX Replacement Cartridges (for LC-8A Inlet), 3/16" ball, 2/Pk	
34-56-00907	OPTI-MAX Outlet Housing & Cartridge	228-09054-93 228-50955-41
10-56-02004	OPTI-MAX Replacement Cartridges (for LC-8A Outlet), 1/8" call, 2/Pk	

OPTIONS: Stainless steel/ceramic OPTI-MAX cartridges are listed above.
For other options, please see page 50.

SEALS & PISTONS

LC-20ABXR, ADXR, LC-20AB, AD, AT, LC-2010, LC-10ADVP, ESA 582 & 584

	ESA#	Shimadzu #
34-36-00855 OPTI-SEAL UHMW-PE* Piston Seal		228-32628-00 228-18745-00 228-35146-00
34-36-00856 OPTI-SEAL UHMW-PE* Piston Seal, 10/Pk		
34-36-04711 ITB PTFE** Piston Seal		228-18745-00, 228-35146-00
34-36-04712 ITB PTFE** Piston Seal, 10/Pk		
34-34-02645 Sapphire Piston for LC-10ADVP, 2010, 20AD (can be used for LC-10AT if user has Plunger Holder P/N 34-34-01991)	70-4052 70-4052 70-4052	228-35601-91 228-35601-92 228-35601-93

LC-20AT, 10AT, 10ATVP, 10AS, 7A, 6A, SIL-10ADVP, GFP

	Shimadzu #
34-36-00865 OPTI-SEAL UHMW-PE* Piston Seal	228-11999-00 228-21975-00 228-35145-00
34-36-00866 OPTI-SEAL UHMW-PE* Piston Seal, 10/Pk	
34-36-00863 ITB PTFE** Piston Seal	228-11999-00 228-21975-00 228-35145-00
34-36-00864 ITB PTFE** Piston Seal, 10/Pk	
34-34-01345 Sapphire Piston for LC-10AS	228-17019-93
34-34-02650 Sapphire Piston for LC-10ATVP	228-35009-92

Piston Wash Users: The above seals can also be used as Back Seals (OEM# 228-28499-00)

LC-10AD, 9A, 600, ESA 580

	Shimadzu #
34-36-00855 OPTI-SEAL UHMW-PE* Piston Seal	228-18745-00
34-36-00856 OPTI-SEAL UHMW-PE* Piston Seal, 10/Pk	228-35146-00
34-36-00857 UHMW-PE* Elastomer Energized Seal	228-18745-00 228-35146-00
34-36-00858 UHMW-PE* Elastomer Energized Seal, 10/Pk	

*UHMW-PE - Ultra High Molecular Weight Polyethylene

**ITB PTFE - Improved PTFE Blend

FILTRATION

LC-10AD, 10AS, 10AT, 9A, 6A, 6AD, 6AEF, 610

	Shimadzu #
34-04-03881 In-Line Filter Assembly	228-12642-93

LAMPS

	Shimadzu #
34-32-02837 DoubleLife Deuterium Lamp, SPD-10A, -10AV, -M10A, -10AS, -10AVP, -M10AVP, -20AV	228-34016-02
34-32-03102 DoubleLife Deuterium Lamp, LC 2010, LC- 2010HT	228-37401-00



THERMO: LDC / MILTON ROY



OPTI-MAX for LDC



31-24-00735



31-24-00736



31-36-00806



31-36-00808



31-36-00745



31-34-00738



31-32-01295

OPTI-MAX® CHECK VALVES

All Analytical**(including Constametric, Minimetric, Minipump, Mini Duplex)**

		OEM #
31-56-00759	OPTI-MAX Inlet Housing & Cartridge	900947001
31-56-00764	OPTI-MAX Outlet Housing & Cartridge	900947002
10-56-02004	OPTI-MAX Replacement Cartridges, 1/8" Ball, 2/Pk	

OPTIONS: Stainless steel/ceramic OPTI-MAX Cartridges are listed above.
For other options, please see page 50.

CHECK VALVE FITTINGS

All Analytical**(including Constametric, Minimetric, Minipump, Mini Duplex)**

		OEM #
31-24-00735	1/8" Nut & Ferrule, for Suction Tube	1960066976
31-24-00736	1/16" Nut & Ferrule, for Discharge Tube	1960066975

SEALS & PISTONS

All Analytical**(including Constametric, Minimetric, Minipump, Mini Duplex)**

		OEM #
31-36-00806	OPTI-SEAL UHMW-PE* Piston Seal	206234
31-36-00807	OPTI-SEAL UHMW-PE* Piston Seal, 10/Pk	
31-36-00808	ITB PTFE** Piston Seal, Black	206129001
31-36-00809	ITB PTFE** Piston Seal, Black, 10/Pk	
31-36-00745	UHMW-PE* Piston Seal, Gold	206234
31-36-00746	UHMW-PE* Piston Seal, Gold, 10/Pk	
31-34-00738	Sapphire Piston	801306

*UHMW-PE - Ultra High Molecular Weight Polyethylene

**ITB PTFE - Improved PTFE Blend

LAMPS

LDC/Milton Roy

		OEM #
31-32-01295	Deuterium Lamp, 3000 and 4000 Series, Spectromonitor I-II-III-D	108035

THERMO: SPECTRA-PHYSICS

OPTI-MAX® CHECK VALVES

8700, 8800, 8810, IsoChrom, P-Series		OEM #
35-56-00956	OPTI-MAX Inlet Housing & Cartridge	A3495-010
35-56-00961	OPTI-MAX Outlet Housing & Cartridge	A3490-010
35-56-00952	OPTI-MAX Transducer Housing & Cartridge	A3990-010
10-56-02004	OPTI-MAX Replacement Cartridges, 1/8" Ball, 2/Pk	

OPTIONS: Stainless steel/ceramic OPTI-MAX Cartridges are listed above.
For other options, please see page 50.

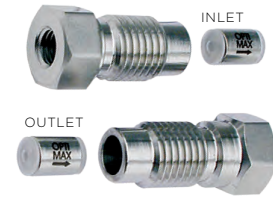

OPTI-MAX for Spectra-Physics

SEALS & PISTONS

8800, 8810, IsoChrom, P-Series		OEM #
35-36-00930	OPTI-SEAL UHMW-PE* Piston Seal	A2962-010
35-36-00931	OPTI-SEAL UHMW-PE* Piston Seal, 10/Pk	
35-36-00938	ITB PTFE** Piston Seal	A2962-010
35-36-00939	ITB PTFE** Piston Seal, 10/Pk	
35-36-00916	Back-Up Seal, PCTFE	A4848-010
35-36-00917	Back-Up Seal, PCTFE, 10/Pk	
35-36-00918	OPTI-SEAL UHMW-PE* Flush Seal	A2963-010
35-36-00919	OPTI-SEAL UHMW-PE* Flush Seal, 10/Pk	
35-36-00920	ITB PTFE** Flush Seal	A2963-010
35-36-00921	ITB PTFE** Flush Seal, 10/Pk	
35-34-00915	Sapphire Piston	A3102-010

8700, 8700XR, 8750		OEM #
35-36-00934	OPTI-SEAL UHMW-PE* Piston Seal	A1703-020
35-36-00935	OPTI-SEAL UHMW-PE* Piston Seal, 10/Pk	

*UHMW-PE - Ultra High Molecular Weight Polyethylene
**ITB PTFE - Improved PTFE Blend

LAMPS

Spectra-Physics		OEM #
35-32-01333	Deuterium Lamp, Spectra-Physics Focus, 100, 200, UV-100, -150, -200, -100, 2000, 3000, CE Series	9551-0023



35-36-00930



35-36-00938



35-36-00916



35-36-00918



35-36-00920



35-34-00915



35-36-00934

VARIAN, GILSON / RAININ



2010 for Varian



2510 for Varian

38-38-04790
for Varian38-56-01067
OPTI-MAX for Varian

26-36-00632



26-36-00630



26-36-00634



26-36-00636



26-34-00625

OPTI-MAX® CHECK VALVES

5, 10 & 25mL S/SC Heads

(Gilson, Rainin, ProStar 210/215, HP, HPX, HPXL, SD 200/300)

		OEM #
26-56-00638	OPTI-MAX Inlet Housing & Cartridge	R007101616, R007101678
26-56-00647	OPTI-MAX Outlet Housing & Cartridge	R007101617, R007101679
10-56-02004	OPTI-MAX Replacement Cartridges, 1/8" Ball, 2/Pk	

2010

		OEM #
38-56-01038	OPTI-MAX Inlet Housing & Cartridge	00-997261-09
38-56-01043	OPTI-MAX Outlet Housing & Cartridge	00-997261-10
10-56-02004	OPTI-MAX Replacement Cartridges, 1/8" Ball, 2/Pk	

2510

		OEM #
38-56-01544	OPTI-MAX Inlet Housing & Cartridge	00-997554-19
38-56-01546	OPTI-MAX Outlet Housing & Cartridge	00-997554-18
10-56-02004	OPTI-MAX Replacement Cartridges, 1/8" Ball, 2/Pk	

9000 Star, 9010, 9012, ProStar 220, 230, 240

		OEM #
38-38-04790	Inlet Check Valve Assembly Includes Installation kit	03-919085-90, 0391908590
38-56-01067	OPTI-MAX Outlet Housing & Cartridge	03-919465-90
10-56-02004	OPTI-MAX Replacement Cartridges, 1/8" Ball, 2/Pk	

OPTIONS: Stainless steel/ceramic OPTI-MAX cartridges are listed above.
For other options, please see page 50.

SEALS & PISTONS

10mL S/SC Heads (Gilson, Rainin, HP, HPX, HPXL, SD 200/300)

		OEM #
26-36-00632	OPTI-SEAL UHMW-PE* Piston Seal	5463125895, R007101447
26-36-00633	OPTI-SEAL UHMW-PE* Piston Seal, 10/Pk	
26-36-00630	ITB PTFE** Piston Seal	5463125095, R007101636
26-36-00631	ITB PTFE** Piston Seal, 10/Pk	

5mL S/SC Heads (Gilson, Rainin, HP, HPX, HPXL, SD 200/300)

		OEM #
26-36-00634	OPTI-SEAL UHMW-PE* Piston Seal	5463088863, R007101634
26-36-00635	OPTI-SEAL UHMW-PE* Piston Seal, 10/Pk	
26-36-00636	ITB PTFE** Piston Seal	5463088063, R007101633
26-36-00637	ITB PTFE** Piston Seal, 10/Pk	
26-34-00625	Piston, 5mL SC Head	3650008, R007101657

ProStar 210/215 (10mL Heads)

		OEM #
38-36-00632	OPTI-SEAL UHMW-PE* Piston Seal	R007101447
38-36-00633	OPTI-SEAL UHMW-PE* Piston Seal, 10/Pk	

VARIAN, GILSON / RAININ

ProStar 210/215 (10mL Heads) (continued)

		OEM #
38-36-00630	ITB PTFE** Piston Seal	R007101636
38-36-00631	ITB PTFE** Piston Seal, 10/Pack	



38-36-01000

ProStar 210/215 (5mL Heads)

		OEM #
38-36-00634	OPTI-SEAL UHMW-PE* Piston Seal	R007101634
38-36-00635	OPTI-SEAL UHMW-PE* Piston Seal, 10/Pk	
38-36-00636	ITB PTFE** Piston Seal	R007101633
38-36-00637	ITB PTFE** Piston Seal, 10/Pk	
38-34-00625	Sapphire Piston, 5mL Head	R007101657



38-36-01002

2010, 2510

		OEM #
38-36-01000	OPTI-SEAL UHMW-PE* Piston Seal	00-997261-37
38-36-01001	OPTI-SEAL UHMW-PE* Piston Seal, 10/Pk	
38-36-01002	ITB PTFE** Piston Seal	00-997261-37
38-36-01003	ITB PTFE** Piston Seal, 10/Pk	
38-34-00999	Sapphire Piston	00-997261-08



38-34-00999

9000 Star, 9010, 9012, 9020, 220, 230, 240

		OEM #
38-36-01555	OPTI-SEAL UHMW-PE* Piston Seal	03-919397-00
38-36-01556	OPTI-SEAL UHMW-PE* Piston Seal, 10/Pk	
38-36-01553	ITB PTFE** Piston Seal	03-919397-00
38-36-01554	ITB PTFE** Piston Seal, 10/Pk	
38-34-01342	Sapphire Piston	03-919180-00, 03-919102-90



38-36-01555



38-36-01553

*UHMW-PE - Ultra High Molecular Weight Polyethylene

**ITB PTFE - Improved PTFE Blend



38-34-01342

LAMPS

Gilson / Rainin Models

		OEM #
26-32-03671	Deuterium Lamp, Gilson/Rainin 115, 116, 117, 118, 119, 151, 152, 155, 156	100326
26-32-03069	Deuterium Lamp, Gilson/Rainin 170 DAD	2140-0590

Varian Models

		OEM #
38-32-01637	Deuterium Lamp, Varian 2050, 2550, 5500	
38-32-03673	Deuterium Lamp, Varian ProStar 330 DAD	0393570502
38-32-02831	DoubleLife Deuterium Lamp, Vista 5000-5500, UV-50, -100, -200, -9050	0391615691
38-32-02081	Deuterium Lamp, Varian ProStar 340, 345, U-VC, UV-DII, UV-M, UVDII, UV	R000088515
38-32-03654	Deuterium Lamp, Varian ProStar 325, 335	110715400
38-32-04022	Xenon Lamp, Varian ProStar 363	392613102



38-32-01637

WATERS

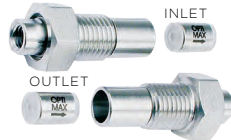

2690/Alliance



100µL Head Systems



225µL Head Systems

400µL, 500µL & 900µL
Heads/Systems

625/626

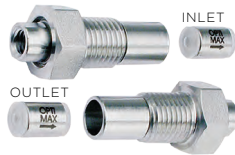

616

OPTI-MAX® CHECK VALVES

2690, 2695, 2790, 2795, Alliance***39-46-01949** OPTI-MAX Inlet Housing & Cartridge**OEM #**

WAT027112, 700002332

10-46-02004 OPTI-MAX Replacement Cartridges,
1/16" Ball, 2/Pk

WAT270941, 700002761

*2690/Alliance Systems have inlet check valves only - outlets are not required.

100µL Head Systems**(M45/45G, M501, 510, 515, 590,****600/600E, 610, 6K/6KA, 1515, 1525, LC Module 1)****39-56-01251** OPTI-MAX Inlet Housing & Cartridge**OEM #**

WAT033679, 700000253

39-56-01256 OPTI-MAX Outlet Housing & Cartridge

700000253

10-56-02004 OPTI-MAX Replacement Cartridges,
1/8" Ball, 2/Pk

700000254, 700002399

225µL Head (#3) Systems**(510, 515, 590, 600/600E, 610, 650, 6K/6KA)****39-66-01262** OPTI-MAX Inlet Housing & Cartridge**OEM #**

WAT033679, WAT060307

10-66-02005 OPTI-MAX Replacement Cartridges,
3/16" Ball, 2/Pk**39-56-01256** OPTI-MAX Outlet Housing & Cartridge

WAT025216

10-56-02004 OPTI-MAX Replacement Cartridges,
1/8" Ball, 2/Pk

700000254, 700002399

400µL (#4), 500µL (#5), & 900µL (#6) Heads**(Delta Prep 3000, 600/600E, 650)****39-66-01267** OPTI-MAX Outlet Housing & Cartridge**OEM #**

WAT033326, WAT033325

10-66-02005 OPTI-MAX Replacement Cartridges,
3/16" Ball, 2/Pk**625/626****39-48-01907** OPTI-MAX Inlet Housing & Cartridge, PEEK**OEM #**

WAT030541

39-48-01909 OPTI-MAX Outlet Housing & Cartridge, PEEK

WAT030543

10-48-02004 OPTI-MAX Replacement Cartridges,
1/16" Ball, 2/Pk

WAT024120

616, 1525µ (Micro)**39-46-01949** OPTI-MAX Inlet Housing & Cartridge**OEM #**

WAT055845

39-46-01950 OPTI-MAX Outlet Housing & Cartridge

WAT055845

10-46-02004 OPTI-MAX Replacement Cartridges,
1/16" Ball, 2/Pk

WAT270941, 700002761

OPTIONS: Stainless steel/ceramic OPTI-MAX cartridges are listed above (except for the 625/626, which requires PEEK housings and cartridges). For other options, please see page 50.

SEALS & PISTONS

Alliance, 2690, 2695, 2790, 2795, 2690D, 2695D, 2796, GPC, V2000

		OEM #
39-36-02596	OPTI-SEAL UHMW-PE* Piston Seal	WAT270938
39-36-02603	OPTI-SEAL UHMW-PE* Piston Seal, 2/Pk	WAT270938
39-36-02597	OPTI-SEAL UHMW-PE* Piston Seal, 10/Pk	
39-36-02855	Face Seals Replacement Kit, 4/Pk	WAT270939
39-36-02856	Seal Wash Face Seal	WAT271017
39-36-02858	Seal Wash Tube Seals Replacement Kit, 4/Pk	WAT270940
39-36-02860	Seal Wash, Piston Seal, Replacement Kit, 2/Pk	WAT271018
39-34-02180	Sapphire Piston	WAT270959

100µL Head Systems

(M45/45G, M501, 510, 590, 600/600E, 610, 6K/6KA, 1515, 1525, 515, LC Module 1)

		OEM #
39-36-01305	OPTI-SEAL UHMW-PE* Piston Seal	WAT022934, WAT022946
39-36-01306	OPTI-SEAL UHMW-PE* Piston Seal, 10/Pk	
39-36-01206	ITB PTFE** Piston Seal, Black	WAT026613
39-36-01207	ITB PTFE** Piston Seal, Black, 10/Pk	
39-36-01208	ITB PTFE** Piston Seal, Red	WAT025638 WAT026613
39-36-01210	ITB PTFE** Piston Seal, Red, 10/Pk	
39-34-01188	Piston, 510, 590, 600/600E, 610, 6K/6KA	WAT025656
39-34-01191	Piston, M45/45G, M501	WAT026524

225µL Head (#3) Extended Flow Systems

(510, 590, 600/600E, 610, 650, 6K/6KA, 515, 1525 EF, LC Module 1)

		OEM #
39-36-01216	OPTI-SEAL UHMW-PE* Piston Seal	WAT026644 700002282
39-36-01217	OPTI-SEAL UHMW-PE* Piston Seal, 10/Pk	
39-36-01214	ITB PTFE** Piston Seal	WAT026644 700002282
39-36-01215	ITB PTFE** Piston Seal, 10/Pk	
39-34-01193	Piston	WAT060304

616, 625/626

		OEM #
39-36-02124	OPTI-SEAL UHMW-PE* Piston Seal	
39-36-02228	OPTI-SEAL UHMW-PE* Piston Seal, 10/Pk	
39-36-02127	ITB PTFE** Piston Seal	WAT031790
39-36-02229	ITB PTFE** Piston Seal, 10/Pk	

*UHMW-PE - Ultra High Molecular Weight Polyethylene

**ITB PTFE - Improved PTFE Blend

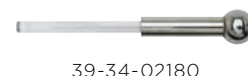

WATERS (CONTINUED)



Waters
39-32-02825



39-04-03524
Filter Insert Assembly



10-04-03151
Solvent Filter



Needle with Nut & Ferrule



Priming Syringe

LAMPS

Waters

		OEM #
39-32-01175	Mercury Lamp, Waters 440, 441	WAT097323
39-32-01179	Deuterium Lamp, Waters 484	WAT080357
39-32-01294	Deuterium Lamp, Waters 450	WAT098946
39-32-01295	Deuterium Lamp, Waters 480, 481, 481AZ	WAT099499
39-32-02823	Deuterium Lamp, Waters 486	WAT080678
39-32-02825	ACQUITY, CapLC 2487, nanoACQUITY Deuterium Lamp, Waters 2487, 2488	WAS081142
39-32-02835	DoubleLife Deuterium Lamp, Waters 996, 2996, PDA	WAT052586
39-32-02688	Xenon Lamp, Waters 490E	WAT046660

FILTRATION

		OEM #
2690/2695, 2790/2795, 600		
39-04-03524	2 μ m Filter Insert Assembly, In-Line	WAT088084
10-04-03151	Solvent Filter, 1/8", 10 μ L, 4/Pk	WAT025531

For additional filtration configurations, see page 23 for solvent reservoir filters.

INLET MANIFOLD PARTS & PRIMING ACCESSORIES

Part No	Description	OEM #
39-31-01171	Optimize Safety Syringe (for pump priming)	WAT027629
39-31-01147	Needle with Nut & Ferrule	WAT025559
39-31-01151	Priming Syringe Kit Includes Priming Syringe, Needle, Nut & Ferrule	

CUSTOM INNOVATION

Partner with Optimize to bring your UHPLC concepts to reality - no challenge is too small or too large. We offer state-of-the-art manufacturing and design in Oregon, USA. Highly experienced engineers, design specialists, chemists, and machinists have exactly what it takes to bring your ideas to fruition.

Please contact us to incorporate Optimize Technologies' patented features into your custom applications. Some of the key industries we serve include Chromatography, Mass Spectrometry, Pharmaceutical Research, Clinical, Environmental, Petrochemical, Defense and other High Pressure Fluidics. We look forward to helping you optimize your laboratory.

- Need a check valve rated to 30,000+ psi (2,100+ bar)?
- Would a quick-connect UHPLC column improve productivity?
- Interested in upgrading your current HPLC system to perform at UHPLC pressures?

THE BEST WAY TO
PREDICT THE FUTURE
IS TO INVENT IT.



OPTIMIZE TRAPPING GUIDE

A PRIMER FOR THE LC OR LC/MS
TECHNIQUE OF OFF-LINE AND
ON-LINE TRAPPING.

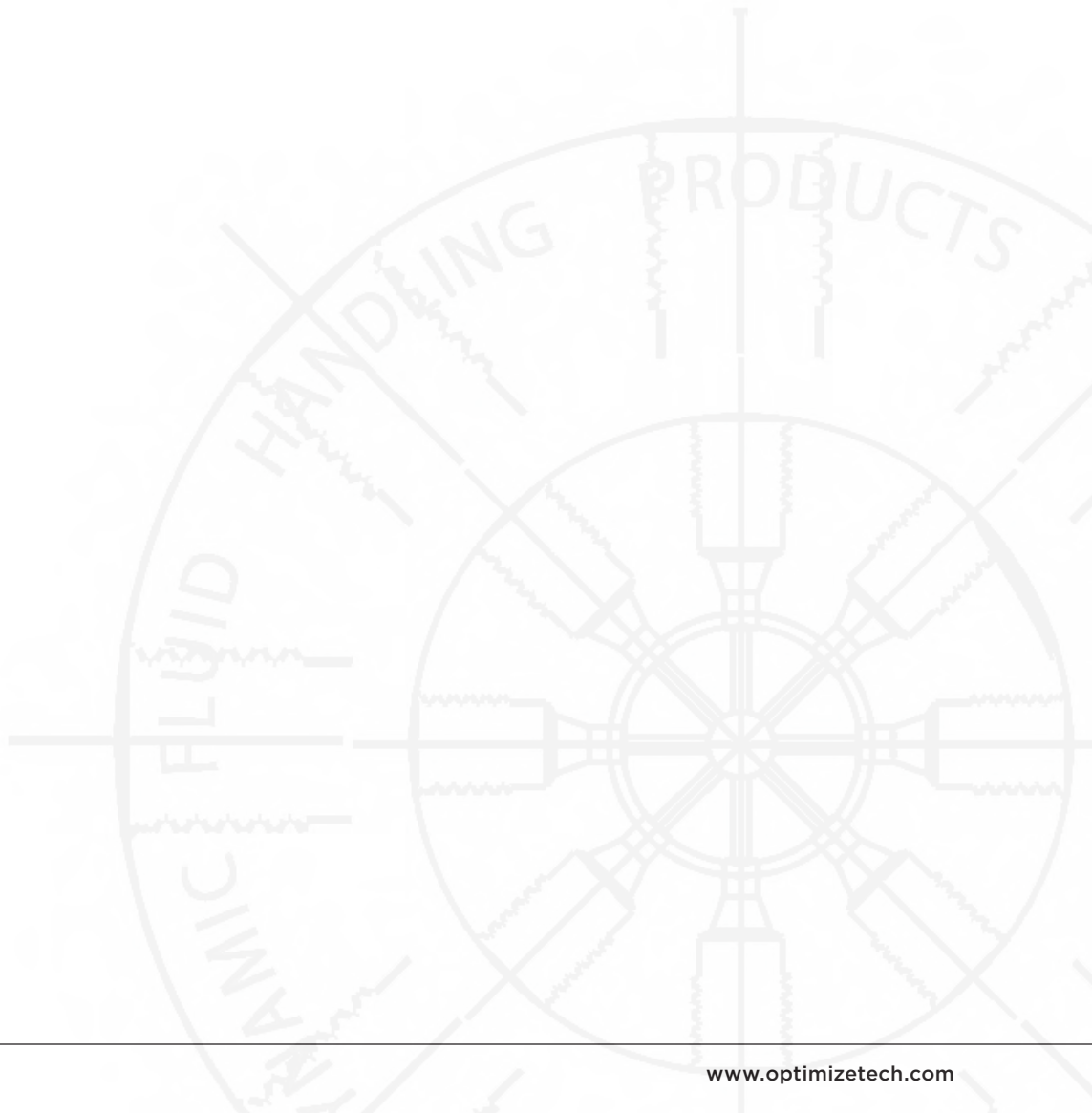

INTRODUCTION

Sample matrix components such as salts, detergents and contaminants present problems for mass spec analysis. Trapping is a chromatography technique that allows for the concentration or purification of a sample. A trap cartridge is a packed column bed loaded with a material to create desirable conditions for separating the target compound from the rest of the sample matrix. By selecting a packing material that has a strong affinity for the target compound, the analyte is retained in the trap while the rest of the sample matrix flows through. Alternately, a material can be selected which has no affinity for the target compound but that binds other unwanted matrix components.

Trap columns are uni-directional or bi-directional and are used either on-line or off-line for sample pre-concentration and clean-up. Trap column bed materials need not be similar to the primary LC column bed materials and can be selected based on sample clean-up needs. Desirable characteristics of a trap include low back pressure, bi-directional flow, robust bed, ability to regenerate the packed bed and low swept volume.

TRAP COLUMNS VS. GUARD COLUMNS

Choosing between traps and guard columns is determined by the application. A guard column is a short, disposable pre-column which removes particulates and contaminants that would otherwise shorten the life of the expensive LC column. A guard column protects the primary column. When selecting a guard column, a bonded phase similar to the primary column should be used.

Optimize Technologies offers several trapping options for LC applications:

- OPTI-TRAP™ - suitable for medium pressure manual and on-line applications (1,500 psi)
- OPTI-LYNX™ - a quarter-turn quick-connect system for HPLC applications (6,000 psi)
- EXP® for UHPLC applications up to 20,000+ psi

Trap columns are offered in a range of bed volumes from 0.12µL to 100µL and can be loaded with a variety of packing materials found in the Trap Column section (pages 29-38). For additional packing materials, please contact Optimize directly.

Trapping is a valuable technique for handling a variety of processes such as sample clean-up, purification, pre-concentration, desalting and detergent removal. In order to retain a target compound within a trap cartridge while flushing the sample matrix and any unwanted contaminants to waste, a packed bed with an affinity for the target compound is used. Alternatively, a packed bed with no affinity for the target compound may be used in order to keep the desired analyte unretained while having the undesired contaminant bound to the stationary phase.

In cases where samples are undesirably dilute, it is possible to increase the concentration of the target analyte in a sample either off-line or on-line. Using a trap cartridge allows the reduction of volume of a sample matrix while concentrating the analyte.

TRAP CARTRIDGES FOR SAMPLE PRE-CONCENTRATION

OFF-LINE SAMPLE PRE-CONCENTRATION

Using a syringe or a small pump along with a trap cartridge that has an affinity for the target analyte, a sample matrix is driven across the trap bed at a flow rate within the recommended range. A slower flow rate is generally considered better.

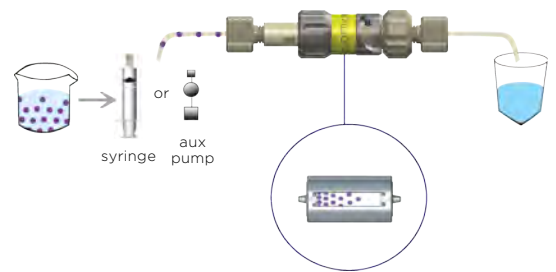

The sample matrix will be sent to waste while the target is analyte retained within the trap. The target analyte is now able to be eluted in a small volume of stronger solvent.



A quick rinse step prior to the elution step is advantageous if salts are present in the sample matrix. Elution takes place either by manual delivery of solvent or by installing the trap cartridge into a holder in-line upstream from an analytical column or within an injection loop.

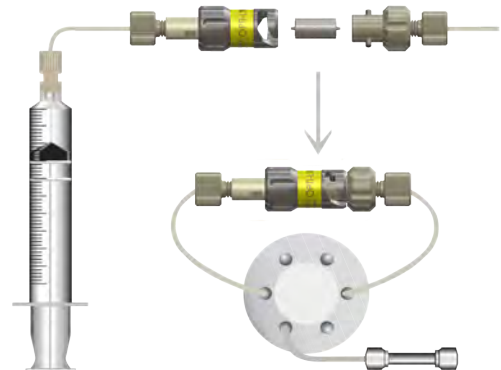

TRAP CARTRIDGES FOR SAMPLE PRE-CONCENTRATION

OFF-LINE SAMPLE PRE-CONCENTRATION

Pre-concentration can be automated by placing a trap cartridge in-line in the loop of an injection or switching valve. This setup allows two different sources to push solvents through the trap depending on the position of the valve.

The sample solution is pushed through the trap bed by an auxiliary pump during the loading phase. After the sample matrix is flushed to waste, it may be beneficial to wash the trap bed with a salt-free solution, ensuring that any buffer salts are rinsed away.

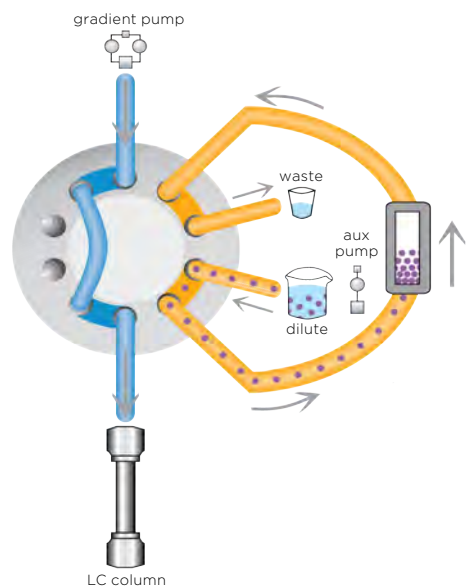

Additional samples may be collected by repeating the sample-loading step with a flushing solvent in order to ensure that any additional sample remaining in the tubing makes it across the packing material during elution.

Using a small volume of suitably strong organic solvent, the concentrated sample can now be eluted.

Eluent can be sent directly to a mass spectrometer or to an analytical column for further separation. If the analyte contains a complex mixture of proteins and peptides, it may be desirable to follow the pre-concentration step with a two-dimensional LC configuration.

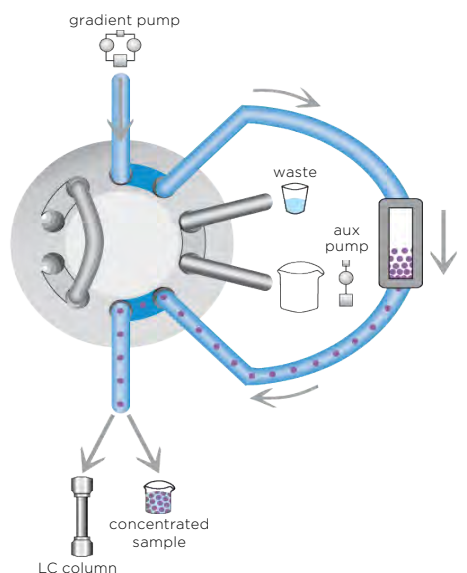

DETERGENT REMOVAL VIA TRAPPING

DETERGENT REMOVAL

Detergents may be present as a result of SDS PAGE analysis or as additions in order to help solubilize a sample. Prior to LC or LCMS analysis, these detergents must be removed.

Many off-line detergent removal methods are time consuming and may result in a significant loss of sample. An on-line trap provides a more convenient and efficient method for detergent removal.

The type of detergent present in a protein sample affects the method of removal. Generally, there are three types of detergents that may be present in a sample: ionic, zwitterionic and non-ionic. Regardless of the method used, the idea is the same: trap the protein, wash detergent to waste and elute the protein or trap the detergent while allowing the protein to pass through.

SDS & IONIC DETERGENT REMOVAL

Ionic detergents such as SDS (sodium dodecyl sulfate) may be removed using a simple ion exchange trap. The packing material used in the trap must have an affinity for the type of charge on the polar head group of the detergent. Anionic detergents require the use of a strong anion exchange (SAX) phase such as a quaternary amine. Alternatively, cationic detergents require use of a strong cation exchange (SCX) phase such as benzenesulfonic acid.

SDS removal is accomplished by using a polymer-based anion exchanger. Mobile phase with a pH of 4.4 or less is used in order to provide conditions where the trap has a maximum affinity for SDS and minimal affinity for the protein sample. The low pH ensures protonated anionic side chains of a protein, reducing the chance of protein interaction with the packing material. Polymeric supports are a more resilient option at a low pH than silica-based anion exchangers. Selective binding of SDS to the trap should occur as the sample is pumped through the trap.

The protein should pass through unretained and may be sent for immediate analysis, or subjected to further on-line purification steps, such as concentration and desalting.

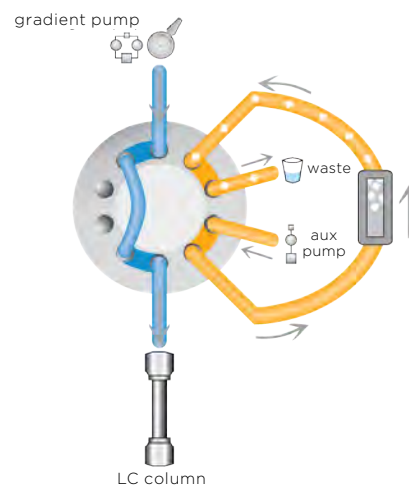
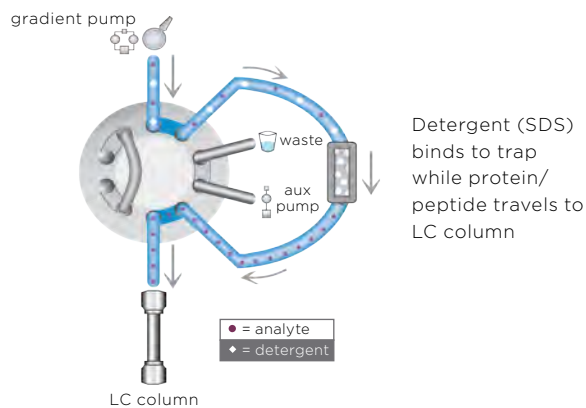

The anion exchange trap will have a finite capacity for SDS and must be regenerated before that capacity is exceeded.

This can be accomplished with a mobile phase that has a high concentration of organic eluent and is strongly acidic. A pH below 2 and an organic content above 90% should be sufficient.

DETERGENT REMOVAL VIA TRAPPING

NON-IONIC DETERGENT (NID) REMOVAL

Non-ionic detergents have hydrophobic characteristics and no charge. Therefore, ion-exchange approaches cannot be used. In NID removal, it is best to temporarily adsorb the protein within a trap while detergent is flushed to waste.

A packed bed with affinity for the target protein and little to no affinity for non-ionic detergents is used for separation.

This packed bed may consist of a single phase such as silica or polymeric SCX or even a mixture of phases such as SCX/SAX.

The most beneficial chemistry for a particular protein sample may need to be determined empirically.

Generally, a sample is delivered to a trap using a mobile phase with a low percentage of organic modifier. The proteins should bind to the packing material while the NID passes through unretained. (fig. 1)

If the isoelectric point (pI) of a protein is at or near the pH of a mobile phase, it may pass through the column unretained. If the pI of a protein is known, pH should be kept below pI for optimal interaction with an SCX trap, and either above or below for a mixed mode SCX/SAX trap. A salt solution of 0.5M concentration can be used to elute the protein after all of the detergent has passed through the trap. A reverse phase bed can be used to desalt the protein before sending it to an MS. In order to keep the desalting trap out of the flow stream during detergent removal, switching valves are required. (fig. 2)

Employing a “normal phase” trap is also a method for discarding of NID. The protein is loaded in high concentrations of organic solvent (80-95% acetonitrile) onto a highly polar stationary phase. The highly organic matrix is introduced in order to maximize the affinity of the sample for the polar stationary phase, and ensures near-complete binding of the sample and elimination of detergent. A gradient of decreasing organic or increasing salt concentration is then used to elute the protein.

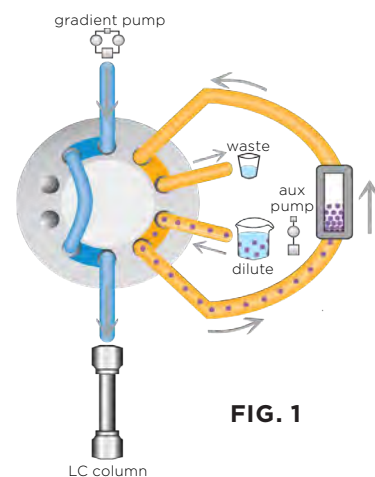

FIG. 1

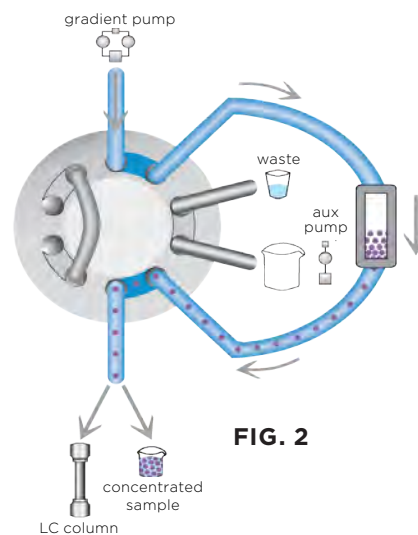

FIG. 2

TRAP SPECIFICS

SMALL MOLECULE CONCENTRATION & DESALTING TRAP

This trap contains a small pore, large particle, hydrophilic C18 silica (ODS-AQ) reversed-phase packing material and is designed to bind small molecules (0.1-10 kD). This includes many organic molecules such as pharmaceuticals, petrochemicals and natural products. Concentration of samples is possible with maximum efficiency. This trap removes salts (8M) and non-volatile buffers and is used at a pH range of 2-7.5.

Quick Reference

1. Clean the trap with 5-10 trap volumes of "B solvent" (typically 90/10/0.005-0.1% acetonitrile/H₂O/ion-pairing acid such as trifluoroacetic acid or heptafluorobutyric acid).
2. Equilibrate the trap with 5-10 trap volumes of "A solvent" (typically 2/98/0.005-0.1% acetonitrile/H₂O/ion-pairing acid such as trifluoroacetic acid or heptafluorobutyric acid).
3. Add appropriate amount of acetonitrile and ion-pairing acid to sample to equal the composition of "A solvent."
4. Load sample onto trap at a loading rate within the recommended speed of loading for the size of trap in use. Do not overload the trap.
5. Remove salts from trap and flush to waste by washing with approximately 5 trap volumes of "A solvent."
6. Elute small molecules from trap. If performing on-line trapping, actuate the valve to the INJECT position and then run an increasing gradient of acetonitrile. For manual trapping, flush the trap with 1-2 trap volumes of 65-90% acetonitrile or "B solvent."
7. For full regeneration, flush the trap with several trap volumes of IPA.

TRAP SPECIFICS

PEPTIDE CONCENTRATION & DESALTING TRAP

Small biological molecules ranging from 0.5-50 kD can be bound and concentrated with a peptide concentration & desalting trap. This is done by using a medium pore, large particle, polymeric reversed-phase packing material with retention similar to a C8 phase. Operating at a pH range of 1-13, this trap removes salts (8M) and non-volatile buffers.

Quick Reference

1. Clean the trap with 5-10 trap volumes of “B solvent” (typically 90/10/0.005-0.1% acetonitrile/H₂O/ion-pairing acid such as trifluoroacetic acid or heptafluorobutyric acid).
2. Equilibrate the trap with 5-10 trap volumes of “A solvent” (typically 2/98/0.005-0.1% acetonitrile/H₂O/ion-pairing acid such as trifluoroacetic acid or heptafluorobutyric acid).
3. Add appropriate amount of acetonitrile and ion-pairing acid to sample to equal the composition of “A solvent.”
4. Load sample onto trap at a loading rate within the recommended speed of loading for the size of trap in use. Do not overload the trap.
5. Remove salts from trap and flush to waste by washing with approximately 5 trap volumes of “A solvent.”
6. Elute peptides from trap. If performing on-line trapping, actuate the valve to the INJECT position and then run an increasing gradient of acetonitrile. For manual trapping, flush the trap with 1-2 trap volumes of 65-90% acetonitrile or “B solvent.”
7. For full regeneration, flush the trap with 70:30 formic acid:IPA.

TRAP SPECIFICS

PROTEIN CONCENTRATION & DESALTING TRAP

When working with large biological molecules ranging from 5-500 kD, a protein concentration and desalting trap may be used for concentration or removal of salts (8M) and non-volatile buffers.

The packed bed consists of a large pore, large particle, polymeric reversed-phase packing material with retention similar to a C4 phase. This functions at a pH range from 1-13.

Quick Reference

1. Clean the trap with 5-10 trap volumes of "B solvent" (typically 90/10/0.005-0.1% acetonitrile/H₂O/ion-pairing acid such as trifluoroacetic acid or heptafluorobutyric acid).
2. Equilibrate the trap with 5-10 trap volumes of "A solvent" (typically 2/98/0.005-0.1% acetonitrile/H₂O/ion-pairing acid such as trifluoroacetic acid or heptafluorobutyric acid).
3. Add appropriate amount of acetonitrile and ion-pairing acid to sample to equal the composition of "A solvent."
4. Load sample onto trap at a loading rate within the recommended speed of loading for the size of trap in use. Do not overload the trap.
5. Remove salts from the trap and flush to waste by washing the trap with approximately 5 trap volumes of "A solvent."
6. Elute proteins from the trap. If performing on-line trapping, actuate the valve to the INJECT position and then run an increasing gradient of acetonitrile. For manual trapping, flush the trap with 1-2 trap volumes of 65-90% acetonitrile or "B solvent."
7. For full regeneration, flush the trap with 70:30 formic acid:IPA.

TRAP SPECIFICS

SDS REMOVAL TRAP

A large pore, large particle, polymeric strong anion exchange packing material is used for these traps. They are designed to bind anionic detergents such as sodium dodecyl sulfate (SDS) at low pH (2-4). This trap removes SDS at concentrations as high as 1%. If higher concentrations of SDS are present in a sample, the risk of forming micelles that trap analytes along with the SDS micelle complex. Such samples must be diluted below 1% first. The trap works at a pH range of 1-13.

Quick Reference

1. Clean the trap with 5-10 trap volumes of “B solvent” (typically 90/10/0.005-0.1% acetonitrile/H₂O/ion-pairing acid such as trifluoroacetic acid or heptafluorobutyric acid).
2. Equilibrate the trap with 5-10 trap volumes of “A solvent” (typically 2/98/0.005-0.1% acetonitrile/H₂O/ion-pairing acid such as trifluoroacetic acid or heptafluorobutyric acid).
3. Add an appropriate amount of acetonitrile and ion-pairing acid to sample to equal the composition of “A solvent.” Note: pH must be between 2-4.
4. Load sample onto trap at a loading rate within the recommended speed of loading for the size of trap in use. Do not overload the trap. SDS will bind to the trap while proteins pass through.
5. Capture proteins as they pass through the SDS removal trap for further analysis. If performing on-line trapping, add 5-10 trap volumes of “A solvent” to allow concentration and desalting of proteins on the protein trap. If performing manual SDS removal, add 1-2 trap volumes of “A solvent” to allow all proteins to pass through SDS removal trap.
6. Actuate the valve to the INJECT position and elute proteins from concentration and desalting trap by running an increasing gradient of acetonitrile. While in the inject position, also clean the SDS trap and route retained SDS to waste by flushing with 5-10 trap volumes of 90% acetonitrile/ 0.1% HCl.
7. Fully regenerate trap by flushing with 90% acetonitrile/ 0.1% HCl.

TRAP SPECIFICS

NID (NON-IONIC DETERGENT) REMOVAL TRAP

Using a mixed bed of large pore, large particle, silica-based weak anion and weak cation exchange packing material, this trap is designed to bind charged proteins and/or peptides. This trap removes non-ionic detergents such as Triton X-100 and Tween-80 by allowing the uncharged detergents to pass through. The trap works at a pH range of 2-7.5.

Quick Reference

1. Clean the trap with 5-10 volumes of 10% acetonitrile/0.5M NaCl.
2. Equilibrate the trap with 5-10 trap volumes of 10% acetonitrile/10mM buffer, pH 7.0 (or some other pH not corresponding to the pI of proteins).
3. Add appropriate amount of acetonitrile and buffer solution to sample to allow sample to contain 10% acetonitrile buffered at pH 7.0 (or at some other pH not corresponding to the pI of proteins).
4. Load sample onto trap at a loading rate within the recommended speed of loading for the size of trap in use. Do not overload the trap. NID will pass through the trap while proteins remain on the NID removal trap.
5. Release proteins from the NID removal trap using 1-2 trap volumes of 10% ACN/0.5M NaCl. If performing on-line trapping, then load 5-10 trap volumes of "A solvent" (typically 2/98/0.005-0.1% acetonitrile/H₂O/ion-pairing acid such as trifluoroacetic acid or heptafluorobutyric acid) to allow concentration and desalting of proteins on the protein trap. Note: some proteins require up to 5% ACN in "A solvent."
6. Actuate the valve to the INJECT position and elute proteins from concentration and desalting trap by running an increasing gradient of acetonitrile.
7. Fully regenerate trap by flushing with 10% acetonitrile/0.5M NaCl.

TRAP SPECIFICS

SCX (STRONG CATION EXCHANGE) TRAP

A packed bed consisting of silica-based strong cation exchange material with medium pores and large particles is designed to bind small positively charged molecules from 0.5 to 50 kD. At a pH of 2.7-3.0, peptides will lose their negative charge and have a net positive charge. The trap is used in a pH range of 2.7 to 7.0. A pH of less than 2.7 will destroy the phase.

Quick Reference

1. Clean the trap with 5-10 trap volumes of "high salt buffer, pH 3" of choice.
Example: 5mM NaH₂PO₄, pH 3.0, with 25% acetonitrile and 0.25M KCl. Note: If using a peptide concentration and desalting trap in tandem with SCX trap for 2D analysis, a good buffer is 5/90/2.5/2.5/0.05% acetonitrile/H₂O/30% ammonium hydroxide/formic acid/HFBA ("D buffer").
2. Equilibrate the trap with 5-10 trap volumes of "low salt buffer." Example: 5mM NaH₂PO₄, pH 3.0, with 25% acetonitrile. Note: If using a peptide concentration and desalting trap in tandem with SCX trap for 2D analysis, a good buffer is 5/95/0.1/0.005% acetonitrile/H₂O/formic acid/HFBA ("C buffer").
3. Add an appropriate amount of acetonitrile and buffer to the sample to obtain pH 3.0 and 25% acetonitrile to match the "C buffer."
4. Load sample onto trap at a loading rate within the recommended speed of loading for the size of trap in use. Do not overload the trap.
5. Release peptides from the trap using 1-2 trap volumes of "high salt buffer" or perform salt steps with increasing concentrations of salt. If performing on-line trapping, then load 5-10 trap volumes of "C buffer" to allow concentration and desalting of peptides on peptide trap.
6. Actuate the valve to the INJECT position and elute peptides from concentration and desalting trap by running an increasing gradient of acetonitrile.
7. For full regeneration, flush the trap with a "high salt buffer" of choice.

TRAP SPECIFICS

ISRP PROTEIN REMOVAL TRAP

This technique utilizes an Internal Surface Reversed Phase trap, which contains a very small pore, large particle, silica-based internal surface, reversed-phase packing material. This trap is designed to bind small molecules (0.1-5 kD) onto C18 chains within the internal surface of the pores of the packing material. Protein removal from plasma, urine and serum samples is possible by excluding the proteins from the shielded hydrophobic phase. This allows them to pass through the interparticulate spaces. This works at a pH range of 2-7.5.

Quick Reference

1. Clean the trap with 5-10 trap volumes of “B solvent” (typically 90/10/0.005-0.1% acetonitrile/H₂O/ion-pairing acid such as trifluoroacetic acid or heptafluorobutyric acid).
2. Equilibrate the trap with 5-10 trap volumes of equilibration buffer, pH 7.0. Example buffer: 5/95 acetonitrile/180mm ammonium acetate.
3. Add appropriate amount of acetonitrile and buffer to sample to equal the composition of the equilibration buffer.
4. Load sample onto trap at a loading rate within the recommended speed of loading for the size of trap in use. Do not overload the trap.
5. Remove proteins and salts from trap and flush to waste by washing with approximately 5 trap volumes of equilibration buffer.
6. Elute small molecules from trap. If performing on-line trapping, actuate the valve to the INJECT position and then run an increasing gradient of acetonitrile. For manual trapping, flush the trap with 1-2 trap volumes of 65-90% acetonitrile or “B solvent.”
7. Fully regenerate the trap by flushing it with IPA.

PATENTS & TRADEMARKS

OPTIMIZE TRADEMARKS

TI-LOK™, OPTI-TRAP™, OPTI-DRAW™, OPTI-LOK™, OPTI-PEEK™, OPTI-LYNX™, HPLC First Aid Kit™, HPLC Switch Kit™, HPLC-Finder™, ITB™, HEAD•LOCK™, “At The Speed of Discovery”™, OS-10.1™, the Optimize Technologies Raindrop Logo, and Free-Turn® are trademarks of Optimize Technologies, Inc.

The OPTI®- prefix, OPTI-MAX®, OPTI-GUARD®, OPTI-PAK®, OPTI-PRIME®, OPTI-SEAL®, OPTI-SOLV®, EXP®, Optimize Technologies® and Velocity® are registered trademarks of Optimize Technologies, Inc.

OPTIMIZE PATENTS

EXP®: U.S. Pat. No.s 8,696,902; D766,055 and U.S. and foreign patents pending.

NON-OPTIMIZE TRADEMARKS

Hastelloy C® is a registered trademark of Cabot Corporation.

PEEKsil® is a trademark of SGE International Pty. Ltd.

Halo® is a registered Trademark of Advanced Materials Technology Inc.

The names of all OEM instrument and equipment manufacturers listed in this catalog are trademarks and/or registered trademarks of their respective owners, as are the names and model numbers of the instruments and equipment referenced herein.

PRODUCT INDEX

A

Adapters, 12
 Agilent, components for, 55-57
 Active Inlet Valve Replacement for Agilent, 55-56
 Alcott, components for, 59
 Altex, components for, 58
 Amersham, components for, 63
 Analytical Columns, 43
 Anspec, components for, 59

B

Back Pressure Regulators, 44
 Beckman, components for, 58
 Bischoff, components for, 59

C

Check valves, cartridge
 OPTI-MAX® Cartridge Check Valve System, 47-50, 53-54
 See also, specific manufacturer pages
 Columns
 Analytical Columns, 43
 Guard Columns, 39-42
 Trap Columns, 29-38
 Conversion Kits, 53-54
 Custom Manufacturing, 1-2, 74

D

Dionex, components for, 60

E

ESA, components for, 65-66
 EXP® and EXP*2 for UHPLC,
 Innovation Spotlight, 3-4
 Fittings, 7-8, 13-18
 Filtration, 21-22, 27-28
 Stem Filter, 27
 Pre-Column Filter, 28
 In-Line Filter, 28
 Multi-Purpose Packed Beds, 29-30, 33-38, 39-40, 42, 43
 Nano Trap, 33-34
 Stem Trap, 35-36

 Trap Column, 37-38
 Guard Column, 42
 Analytical Column, 43

F

Filters, 21-28
 Introduction, 21-22
 Solvent Reservoir Filters
 OPTI-SOLV® Solvent Reservoir, 23
 Pre-Column and In-Line Filters
 OPTI-SOLV® In-Line, 24
 OPTI-SOLV® Mini, 25
 OPTI-SOLV® Micro, 26
 OPTI-SOLV® Nano, 26
 EXP® Stem, 27
 EXP*2 Pre-Column, 28
 EXP*2 In-Line, 28
 Fittings, 7-18
 Introduction, 7-8
 OPTI-LOK™ Low Pressure, 9
 OPTI-LOK™ High Pressure, 10
 OEM Specific Fittings, 11
 OPTI-LOK™ Adapters, 12
 EXP® and EXP*2 for UHPLC, 3-4, 7-8, 13-18
 Free-Turn® Introduction, 49

G

Gilson, components for, 69-70
 Guard Columns, 39-42
 Introduction, 39-40
 OPTI-GUARD® 1mm, 41
 EXP® Guard Column, 42

H

Hitachi, components for, 61
 Hewlett Packard, components for, 55-57
 HPLC Finder™, 46

J

Jasco, components for, 62

L

Lamps, 57, 60, 62-64, 66-68, 70, 73

See specific manufacturer pages

LDC (Thermo), components for, 67

LKB, components for, 63

M

Milton Roy (Thermo), components for, 67

O

OPTI-GUARD® 1mm Guard Column, 41

OPTI-LOK™ Fittings, 7-12

OPTI-LYNX™ Quick-Connect System, 5-6, 22, 30, 32, 40

Innovation Spotlight, 5-6

Micro Trap, 32

OPTI-MAX® Cartridge Check Valves, 45-50, 55-56, 58-65, 67-69, 71

Introduction, 47-50

Conversion Kits, 53-54

Replacement Cartridges, 50

OPTI-PAK® Trap Column, see EXP® Stem Trap, 35-36

OPTI-PEEK™ Tubing, 20

OPTI-SOLV® Filters, 23-26

OPTI-TRAP™ Trap Columns, 31

Ordering Information, 91

P

Patents, 88

PerkinElmer, components for, 64

Pharmacia, components for, 63

Pistons and Seals, 45, 51

See also, specific manufacturer pages

R

Rainin, components for, 69-70

Regulators, Back Pressure, 44

S

Seals and Pistons, 45, 51

See also, specific manufacturer pages

Seal Form Insertion Tool Kit, 52

Shimadzu, components for, 65-66

Spectra-Physics (Thermo), components for, 68

T

Thermo, components for, 67-68

Trademarks, 88

Trap Cartridges / Columns, 29-38

Introduction, 29-30

OPTI-TRAP™ Trap Columns, 31

OPTI-LYNX™ Micro Trap, 32

OPTI-PAK® Trap Column, see EXP® Stem Trap, 35-36

EXP® and EXP*2 for UHPLC

Nano Trap, 33-34

Stem Trap, 35-36

Trap Column, 37-38

Trapping Guide, 75-87

Tubing, 19-20

OPTI-PEEK™, 20

Stainless Steel, 20

PTFE, 19

ETFE, 19

Tubing Cutters, 20

U

UHPLC | EXP® and EXP*2

Innovation Spotlight, 3-4

Fittings, 7-8, 13-18

Filtration, 21-22, 27-28

Stem Filter, 27

Pre-Column Filter, 28

In-Line Filter, 28

Multi-Purpose Packed Beds, 29-30, 33-38, 39-40, 42-43

Nano Trap, 33-34

Stem Trap, 35-36

Trap Column, 37-38

Guard Column, 42

Analytical Column, 43

OPTI-MAX® Check Valve Cartridges, 50

See also, specific manufacturer pages

Seals, Pistons and Other OEM Components

See specific manufacturer pages

V

Varian, components for, 69-70

Velocity® Analytical Column System

See EXP® Analytical Columns, 43

W

Waters, components for, 71-73

ORDERING INFORMATION

OUR GUARANTEE OF SATISFACTION

Optimize products are fully guaranteed to meet or exceed original equipment specifications and to meet or exceed your expectations. Satisfaction is guaranteed. If our products do not meet your expectations, please contact Optimize or the distributor from whom you purchased the item. A Return Materials Authorization (RMA) number must be obtained before the product can be returned. The RMA number allows us to properly identify returned goods and to resolve problems quickly and efficiently. Optimize Technologies is not responsible or liable for goods returned without prior authorization.

TERMS AND CONDITIONS

Net 30 days from invoice date with approved credit. We also accept credit cards and prepayment orders. Charges for shipping and insurance are prepaid and added to invoices.

PRICING

Prices published in print or on the web are subject to change without prior notice. For current pricing and availability, please contact Optimize.

SHIPPING

All goods listed in this catalog are shipped FOB Oregon City, Oregon, USA. Standard/stock items are usually shipped within 24 hours. Shipments are sent best way (UPS or FedEx) unless alternate shipping instructions are provided. Orders placed by 12:00 PM PST are usually shipped the same day if in stock.

TO ORDER IN THE U.S. OR INTERNATIONALLY

Orders can be placed on our website at www.optimizetech.com or with your preferred authorized Optimize distributor. The latest authorized distributor list is available on our website. We accept Visa, Mastercard, American Express, check, and purchase orders with approved credit. If you prefer to place an order by phone or fax, please contact Optimize at the numbers below.

Phone: 800.669.9015 or 503.557.9994

Fax: 503.557.9995

Mailing and Shipping Address:

Optimize Technologies, Inc.

13993 Fir Street

Oregon City OR 97045, USA

While every effort has been made to ensure the accuracy of information contained in our catalogs, price lists and web sites, Optimize Technologies, Inc. accepts no responsibility for errors or omissions.

Join Optimize in supporting CASA

Court Appointed Special Advocates (CASAs) are a special kind of volunteer. When a child is removed to protective custody, their volunteer advocate provides a voice in court and dedicated support in finding the safe and permanent home where he or she will thrive.

CASA volunteers contact caseworkers, interview parents and other family members, ensure children receive necessary medical care, look out for educational interests, and make recommendations in court regarding the permanent placement of the child. Most importantly, they serve as a constant person for that child to count on during a very tumultuous time.

Today, the National CASA Association represents more than 948 CASA programs in 49 states, Washington, D.C., and the U.S. Virgin Islands. It provides support for starting programs, technical assistance, training, fundraising, media, and public awareness services.

Since its creation in 1977, CASA has had a dramatic impact on the nation's court system. Programs often differ from one jurisdiction to another, with varying operation methods and sources of funding. CASA is known at the local level by a variety of other names. Some examples are: Voices for Children, ProKids, or Guardian Ad Litem (GAL).

Optimize is a proud supporter of our local CASA chapter. To support your local CASA program or become a volunteer, please visit casaforchildren.org.



503.723.0521 | WWW.CASA-CC.ORG | OFFICE@CASA-CC.ORG

INNOVATIVE HPLC,
UHPLC & LC/MS PRODUCTS



OPTIMIZE

13993 Fir Street

Oregon City, OR 97045

TF: 800.669.9015 | Tel: 503.557.9994 |

Fax: 503.557.9995

www.optimizech.com

